

6101

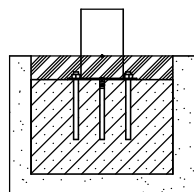

6101 F0

6101 F0

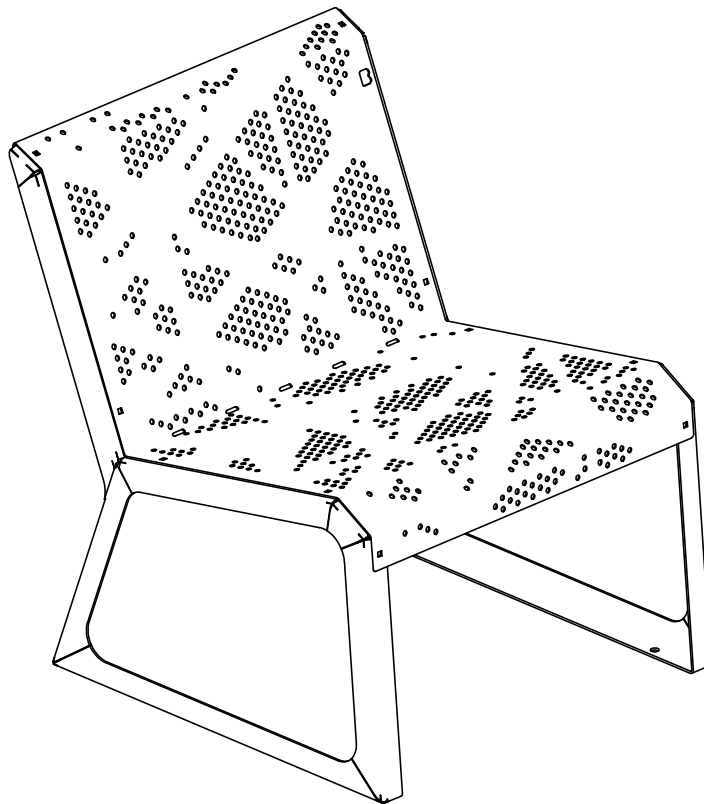
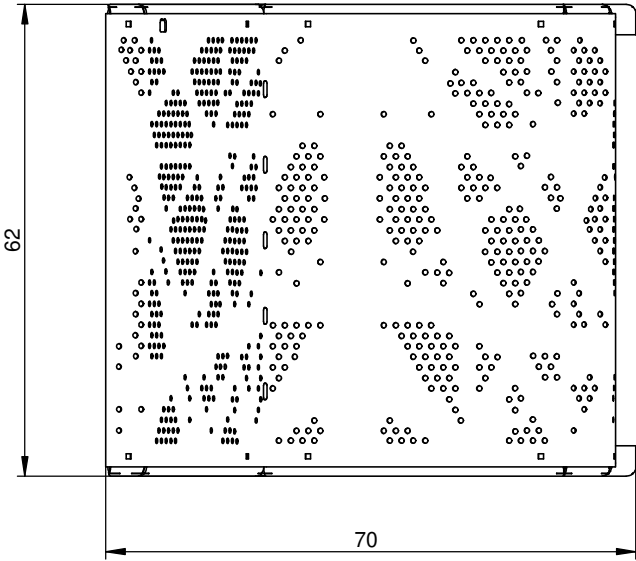
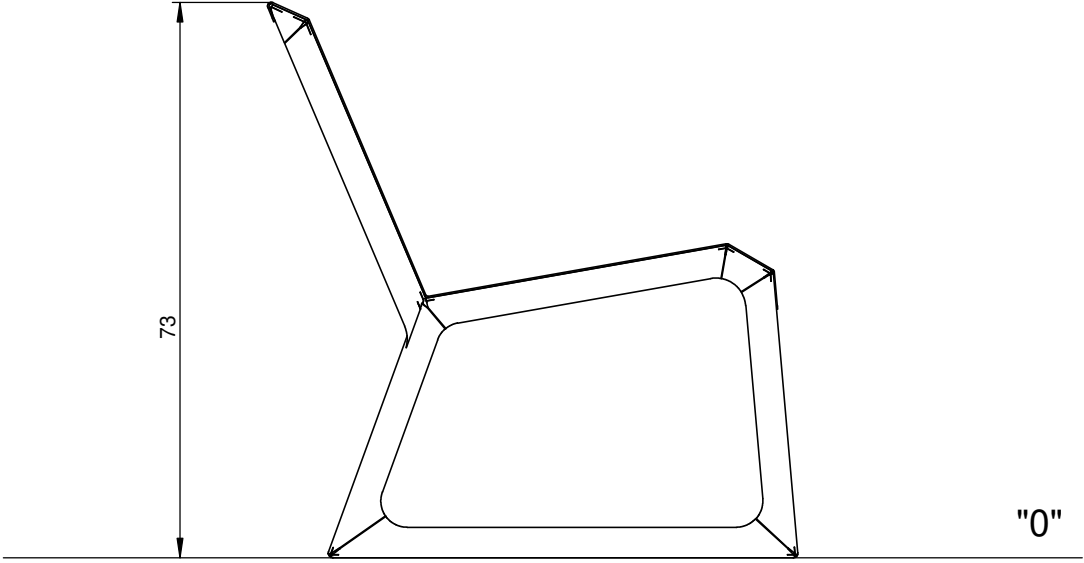



6101 F0

B25 0,15m³

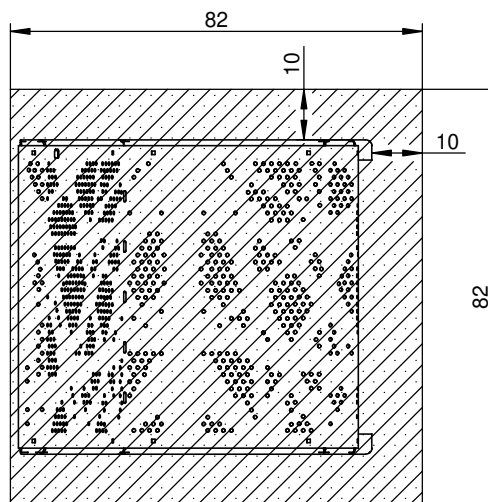
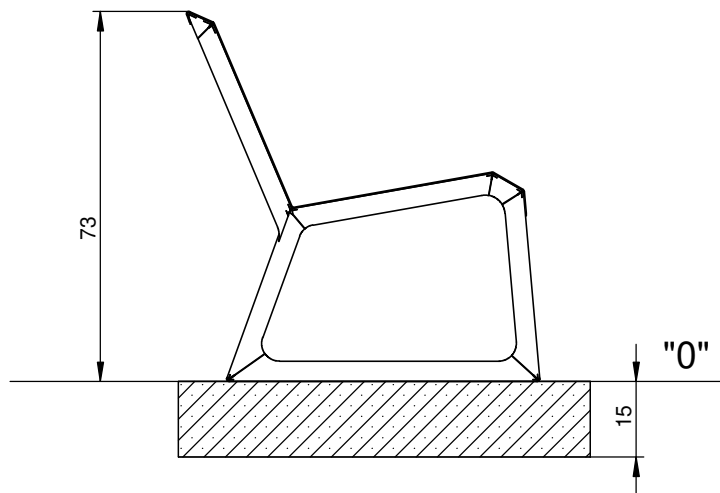
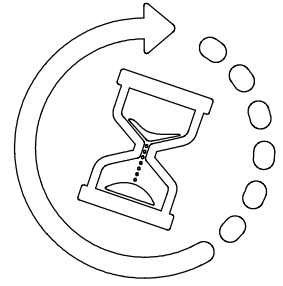
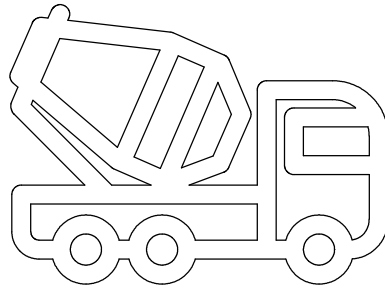
min. 24H



6101F

Nr	Element		
57		DIN 1587	M10
61		-	KL105 (OC)

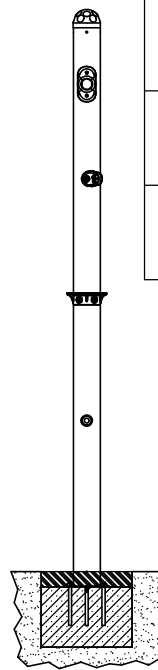
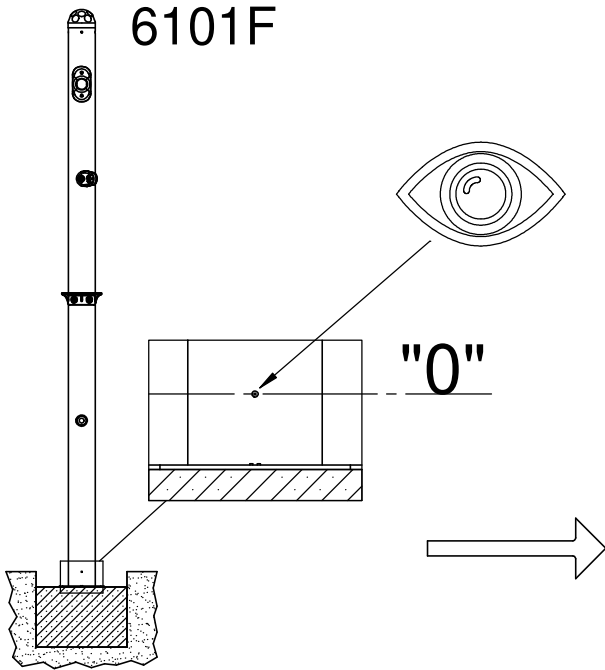

I

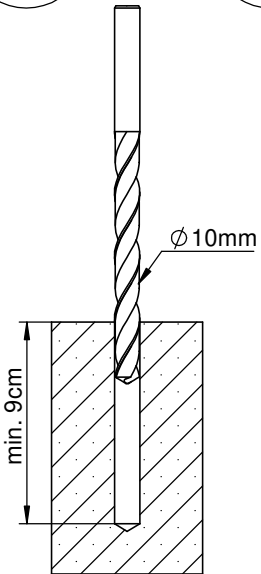

II

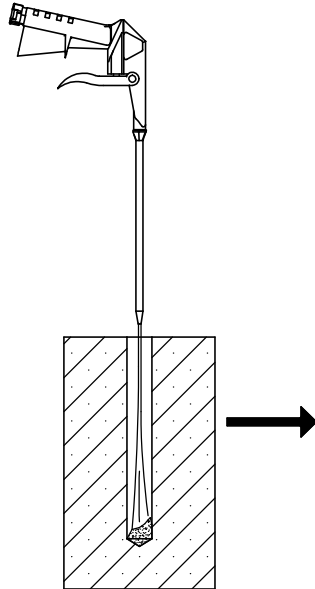

III

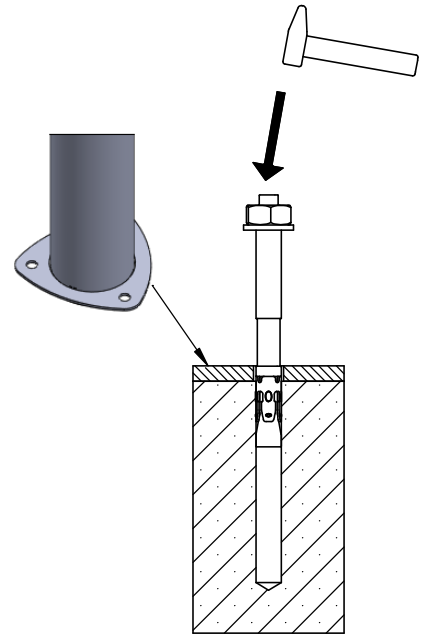

IV

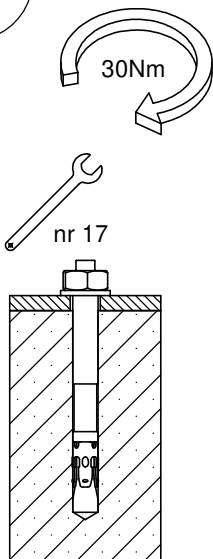

V

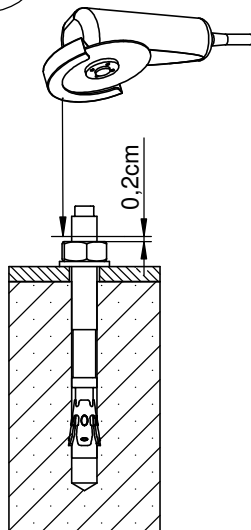

VI

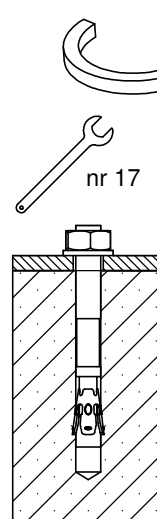

VII

