

6103

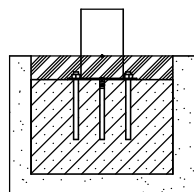

6103 F0

6103 F0

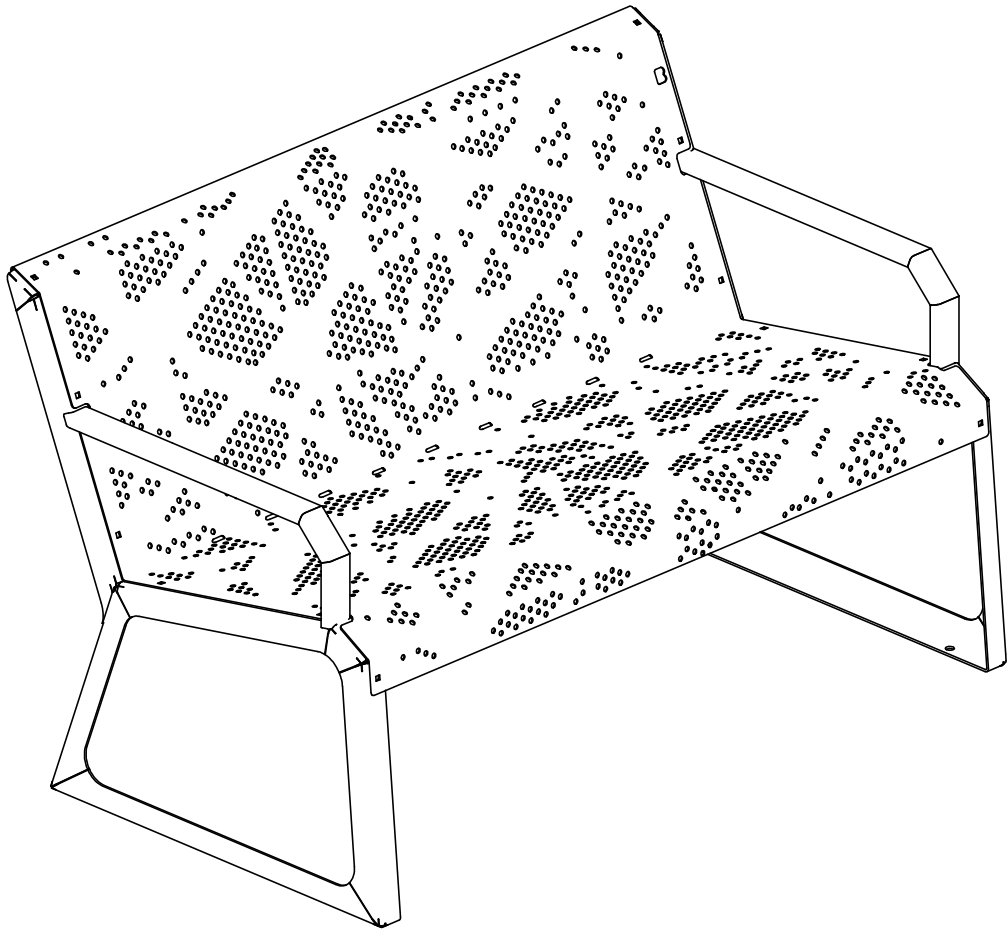
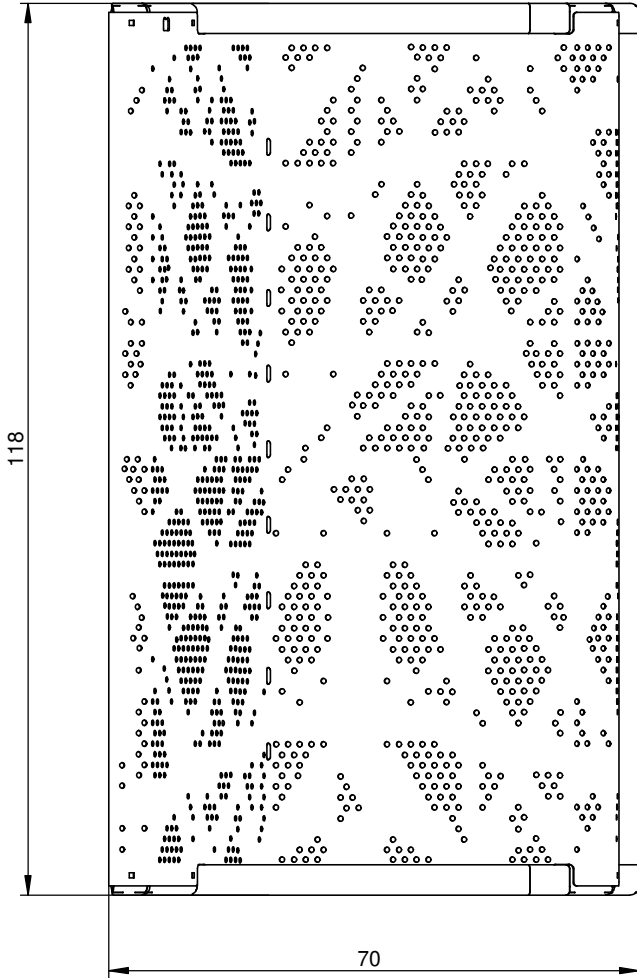
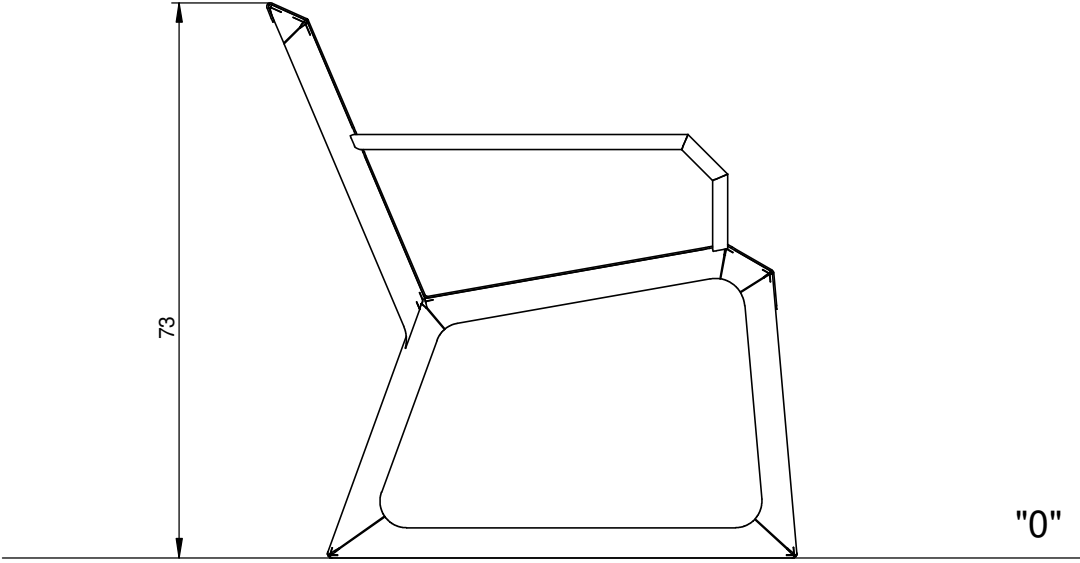



6103 F0

B25 0,15m³

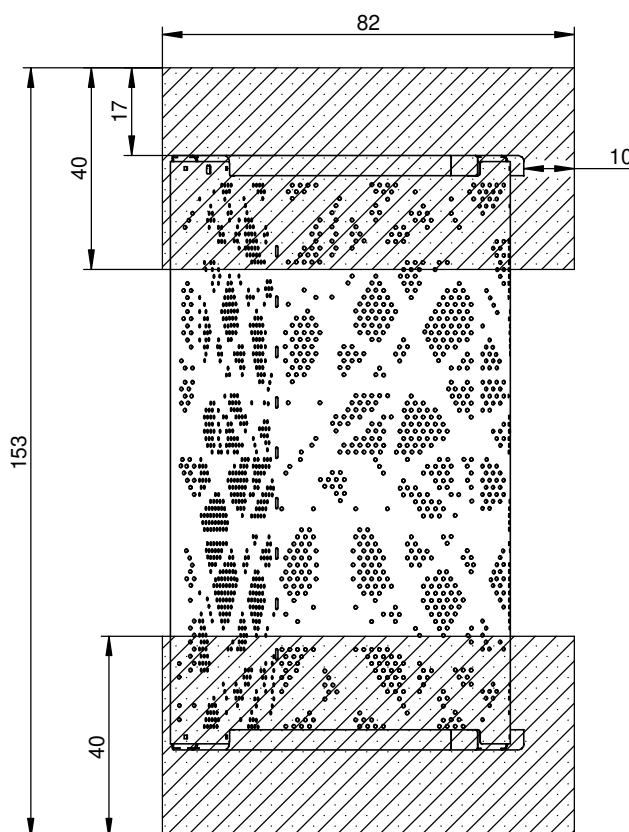
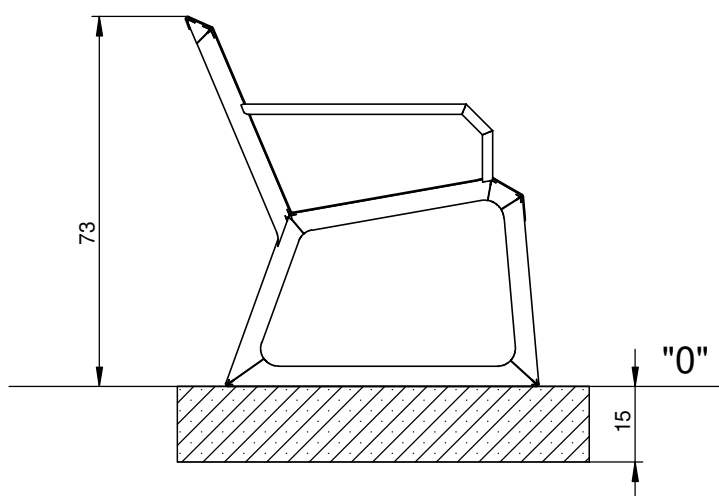
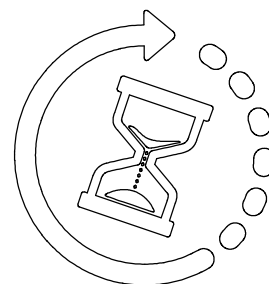
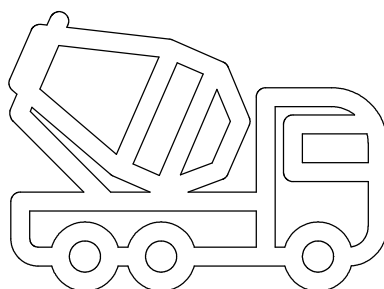
min. 24H



6103F

Nr	Element		
57		DIN 1587	M10
61		-	KL105 (OC)

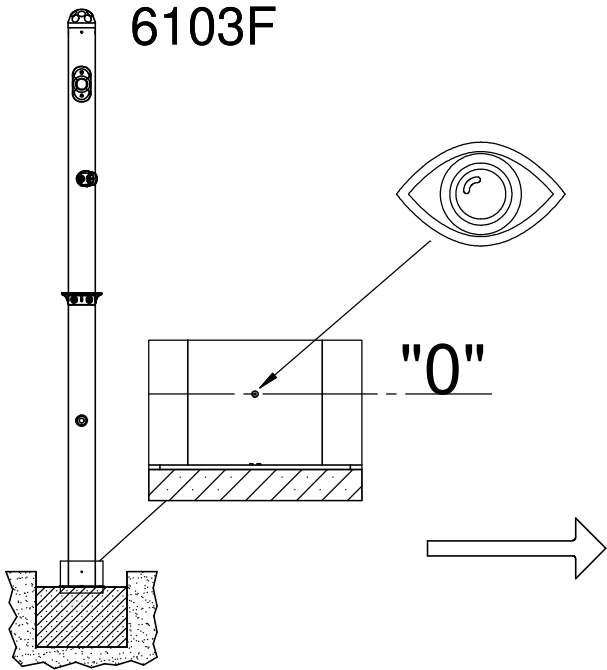

I

II

III

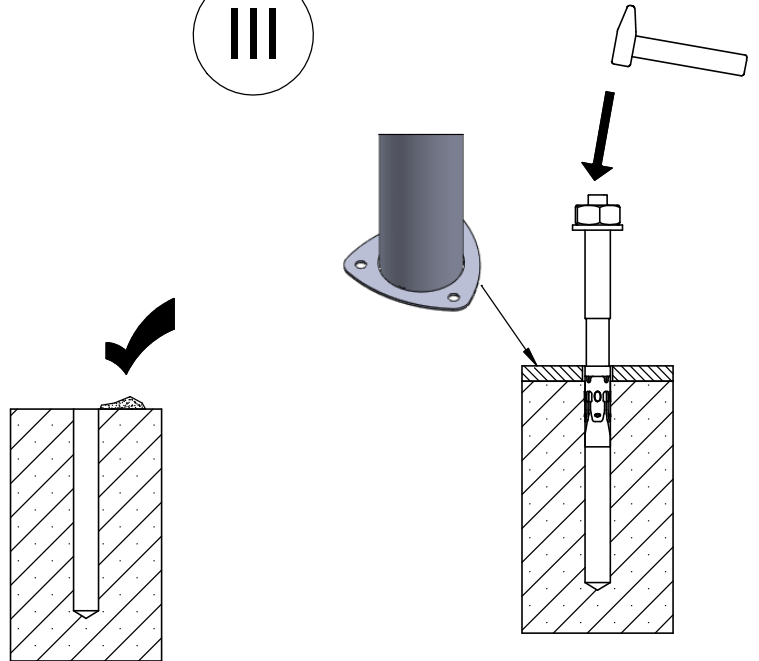
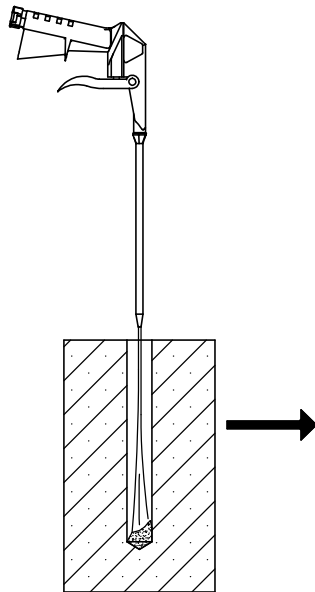
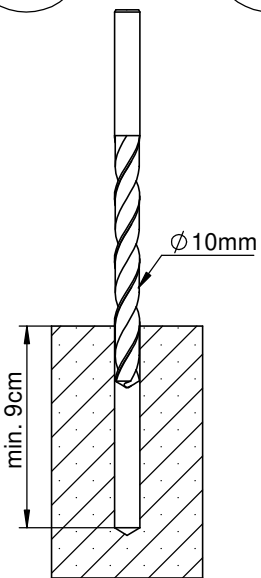

IV

V

VI

VII

