

6109

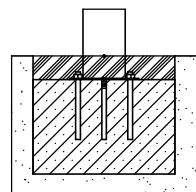

6109 F0

6109 F0

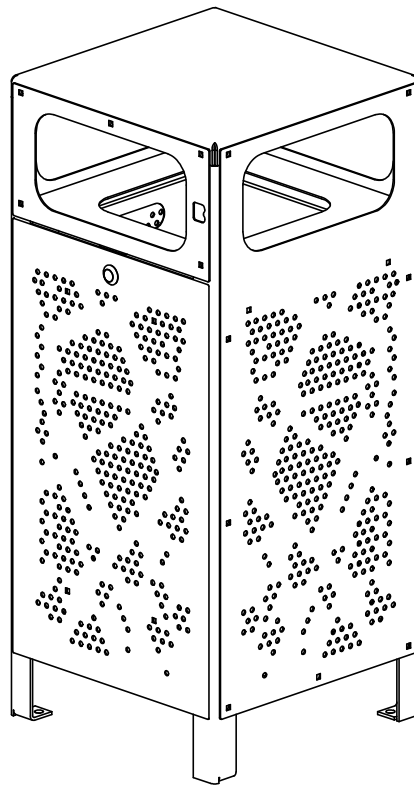
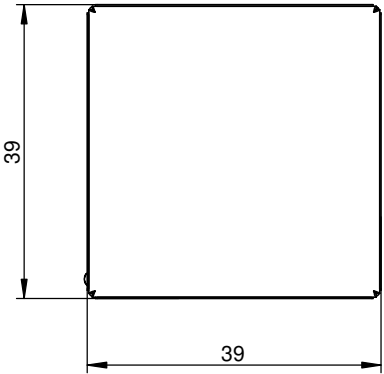
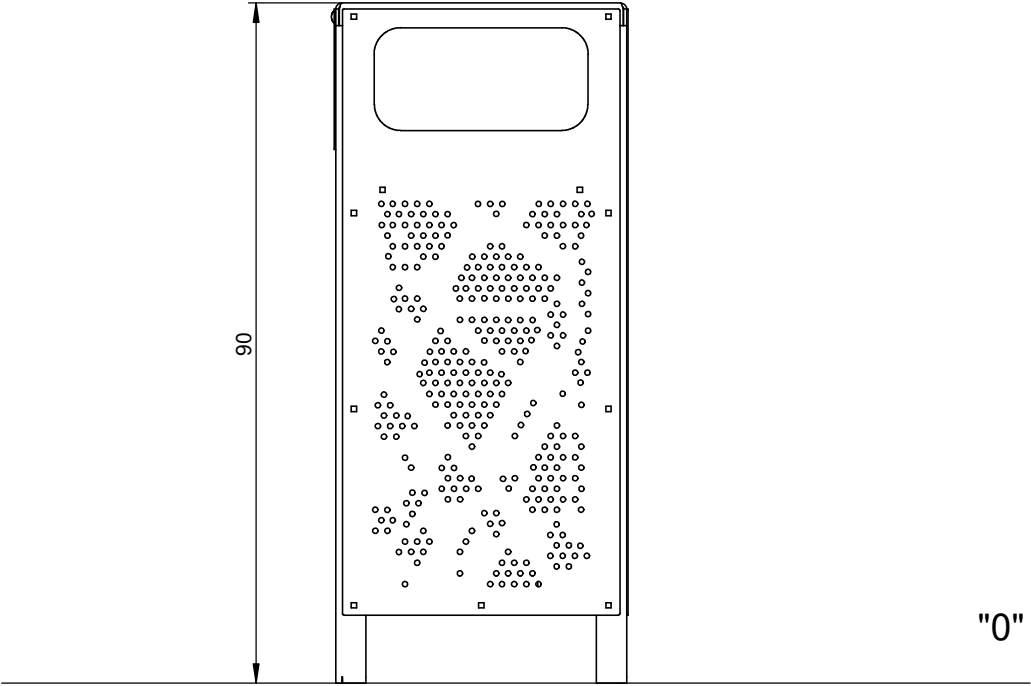



6109 F0

B25 0,1m³

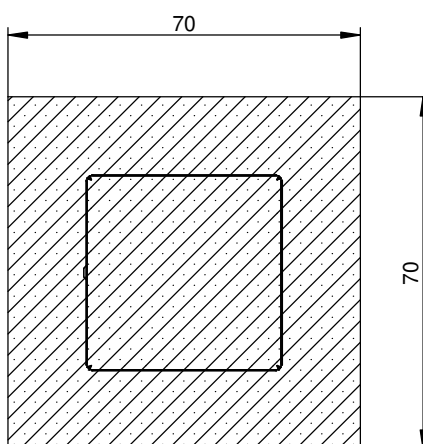
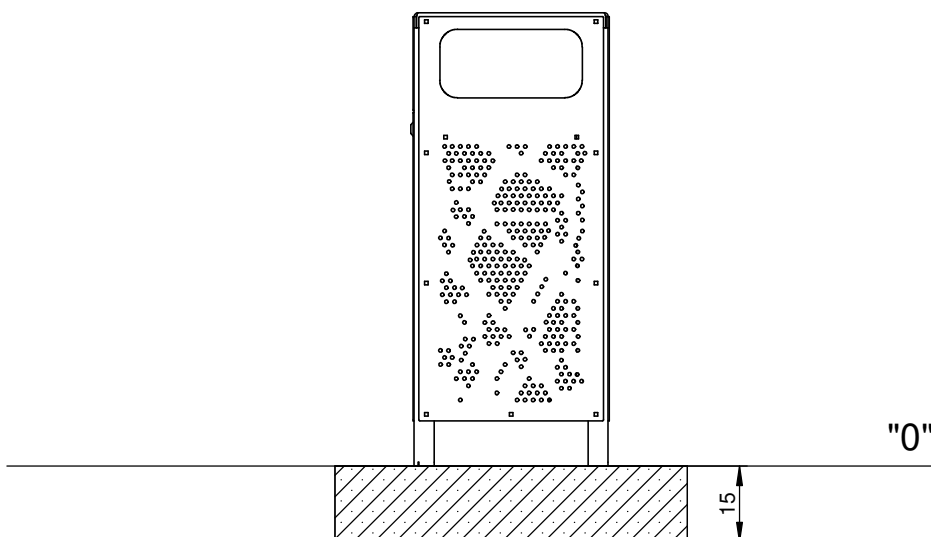
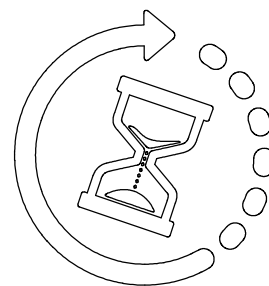
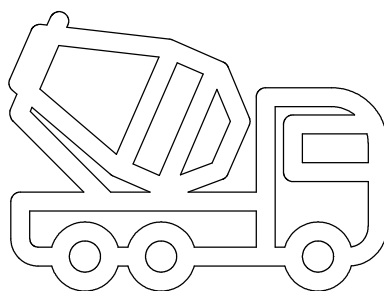
min. 24H



6109F

Nr	Element		
57		DIN 1587	M10
61		-	KL105 (OC)

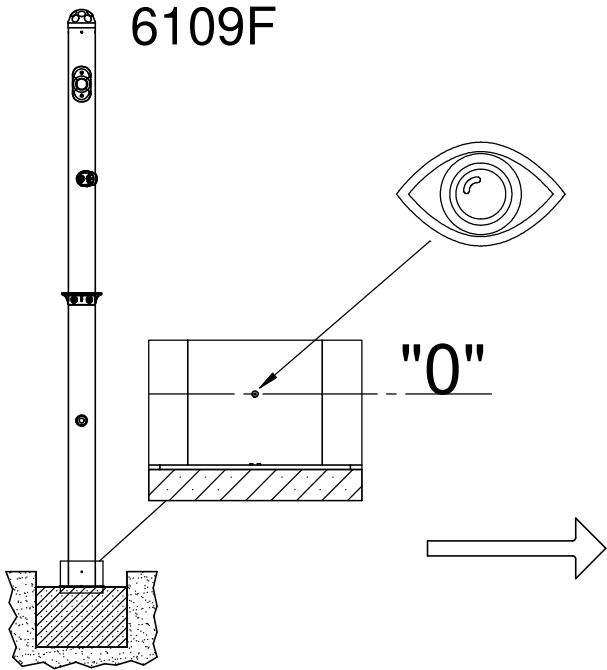

I

II

III

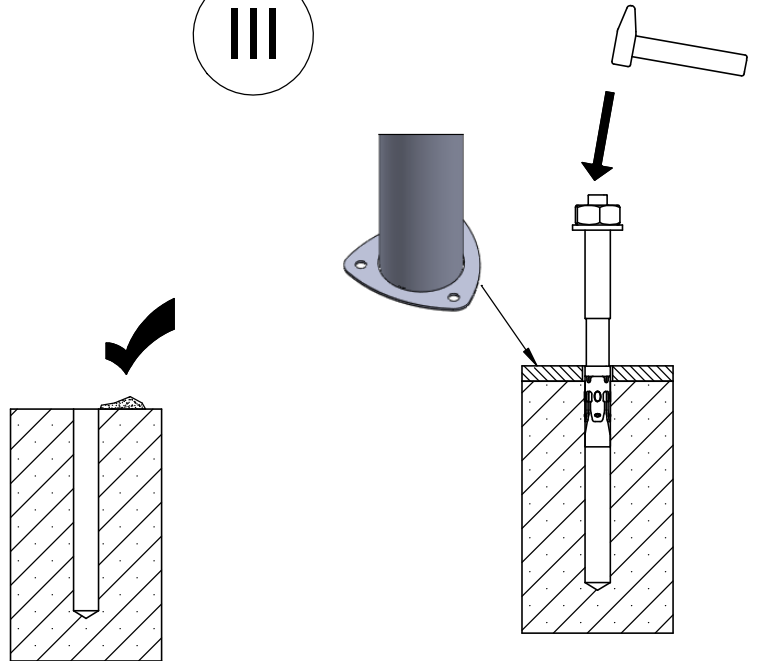
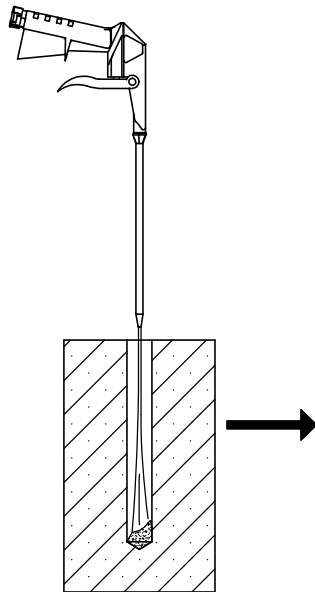
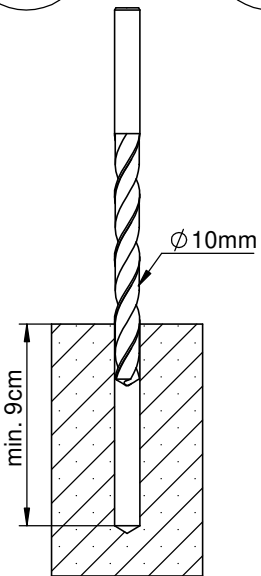

IV

V

VI

VII

