

6112

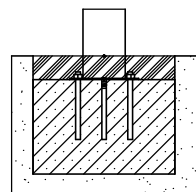

6112 F0

6112 F0

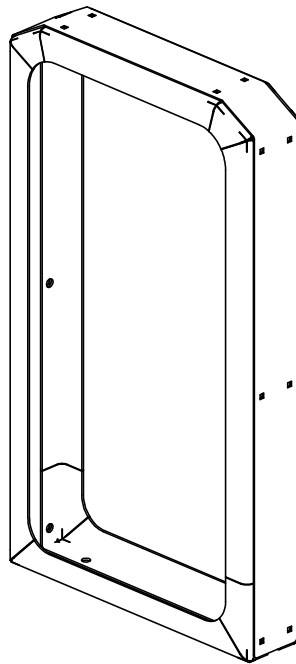
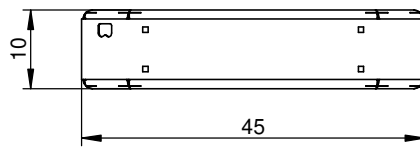
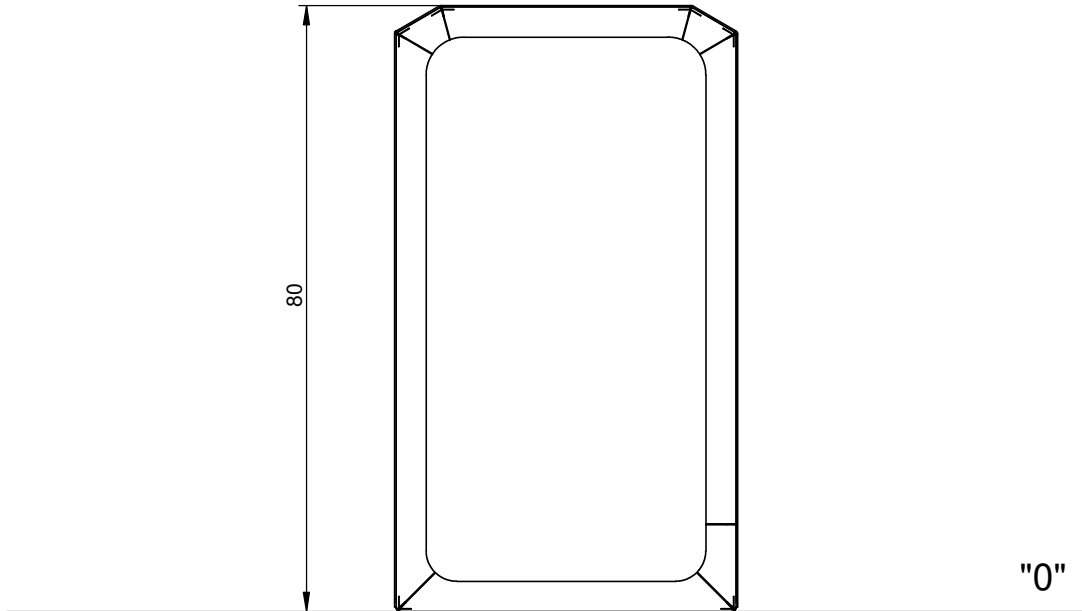



6112 F0

B25 0,1m³

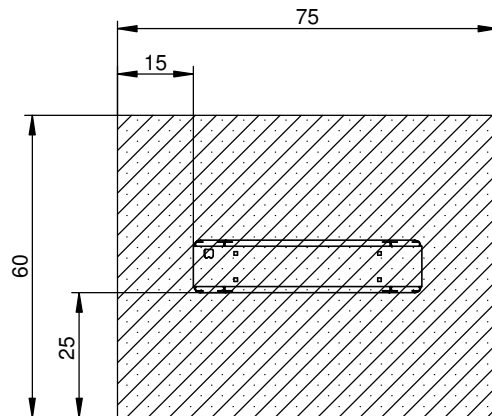
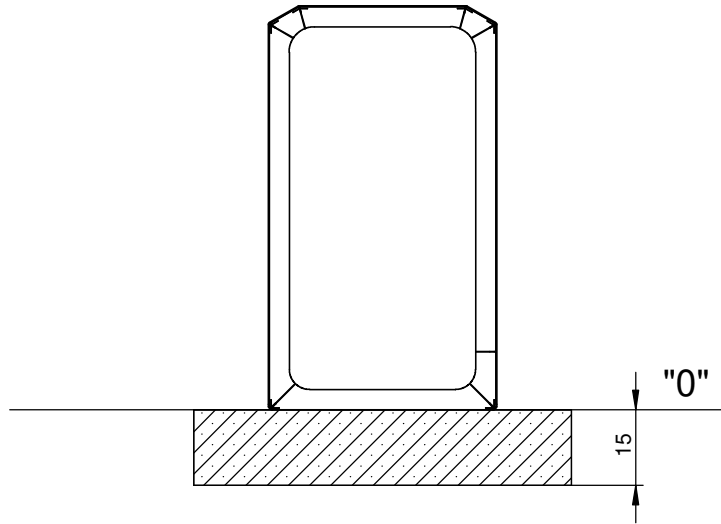
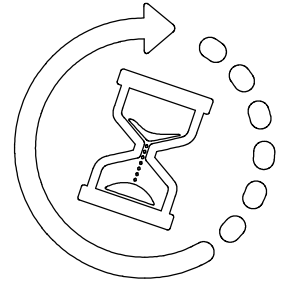
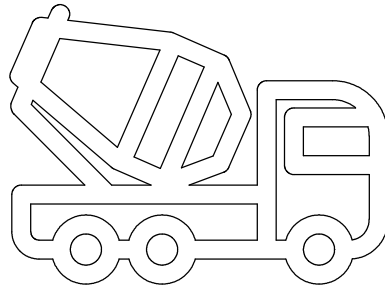
min. 48H



6112F

Nr	Element		
57		DIN 1587	M10
61		-	KL105 (OC)

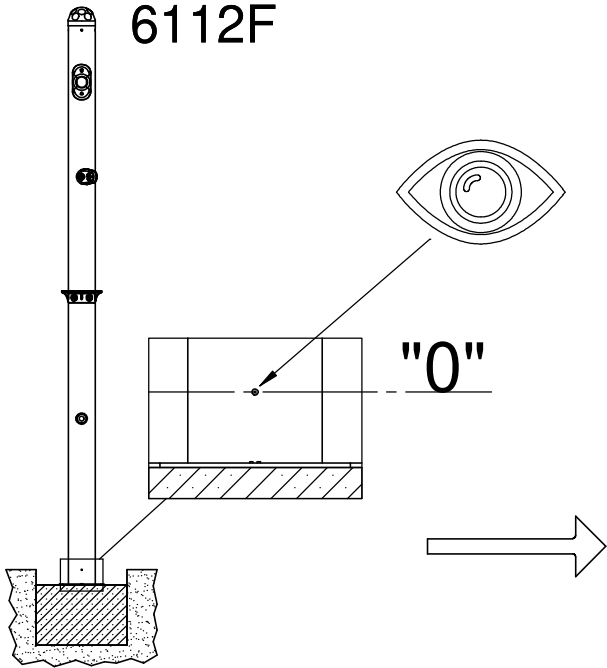

I

II

III

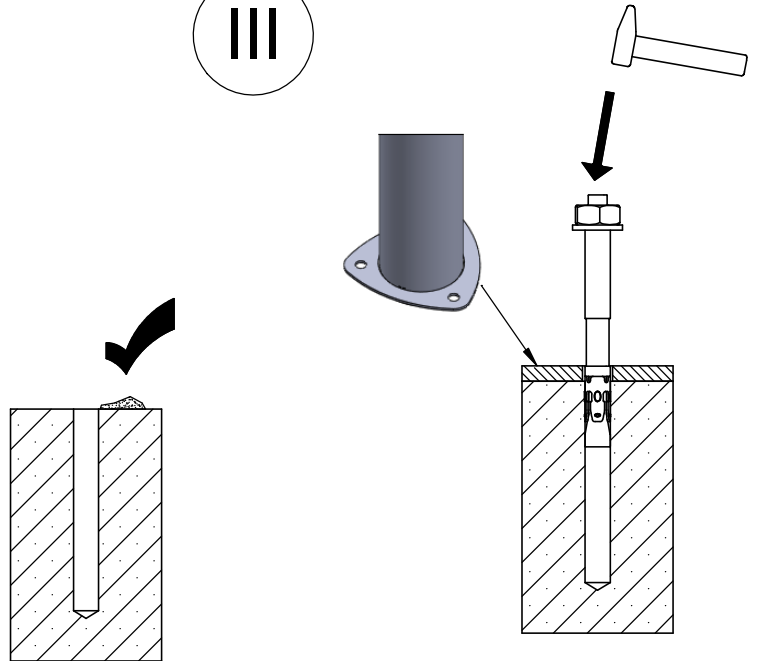
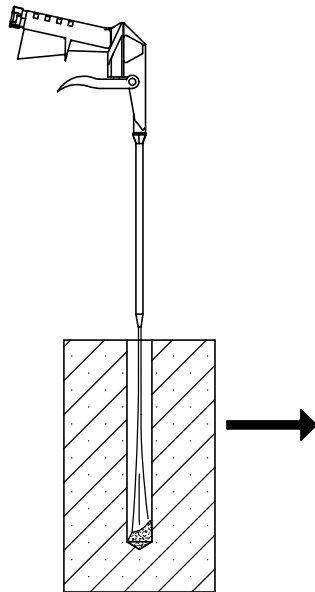
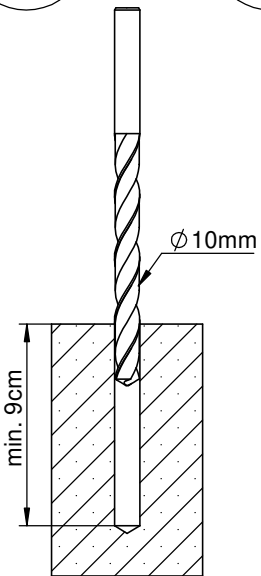

IV

V

VI

VII

