

6114

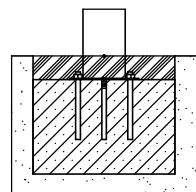

6114 F0

6114 F0

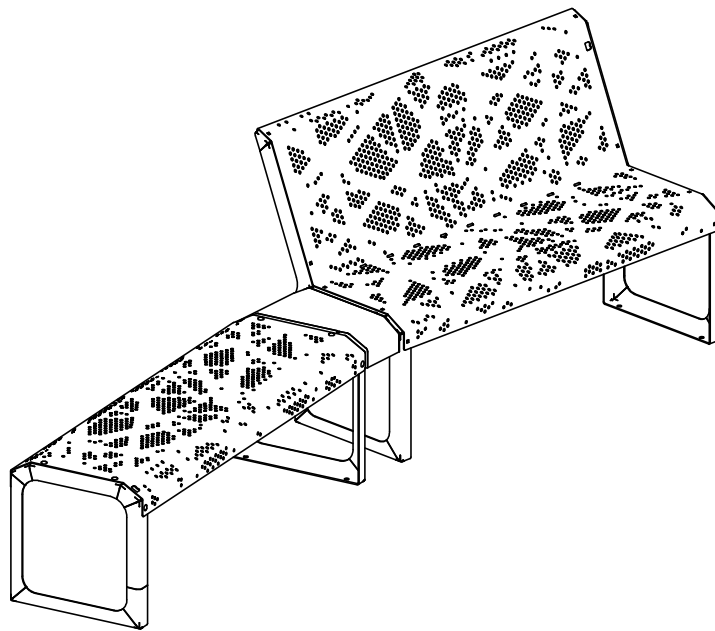
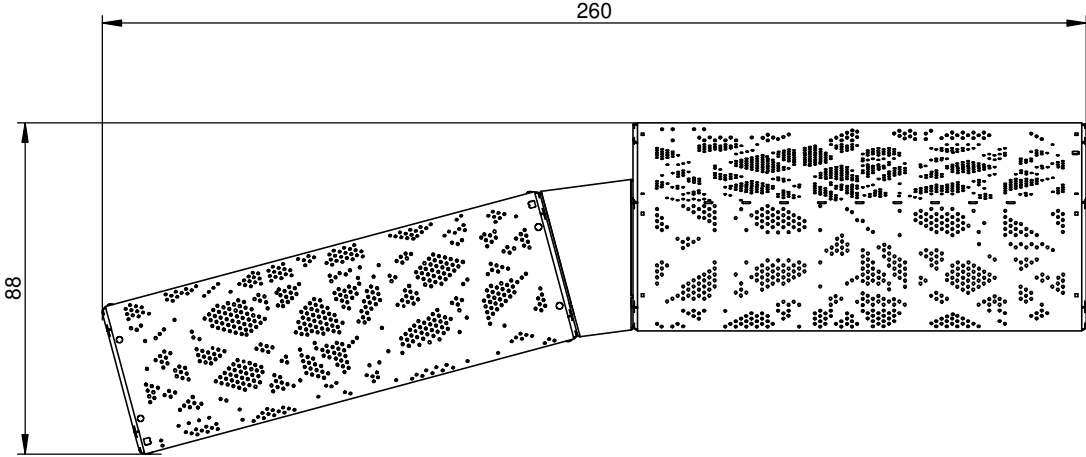
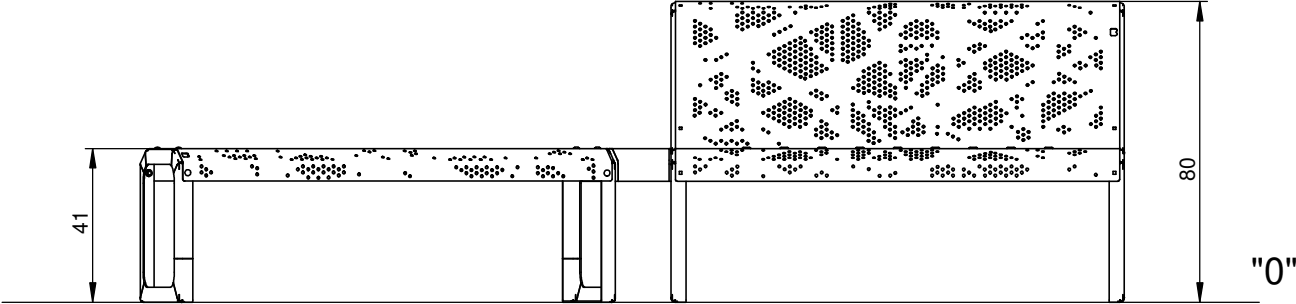



6114 F0

B25 0,2m³

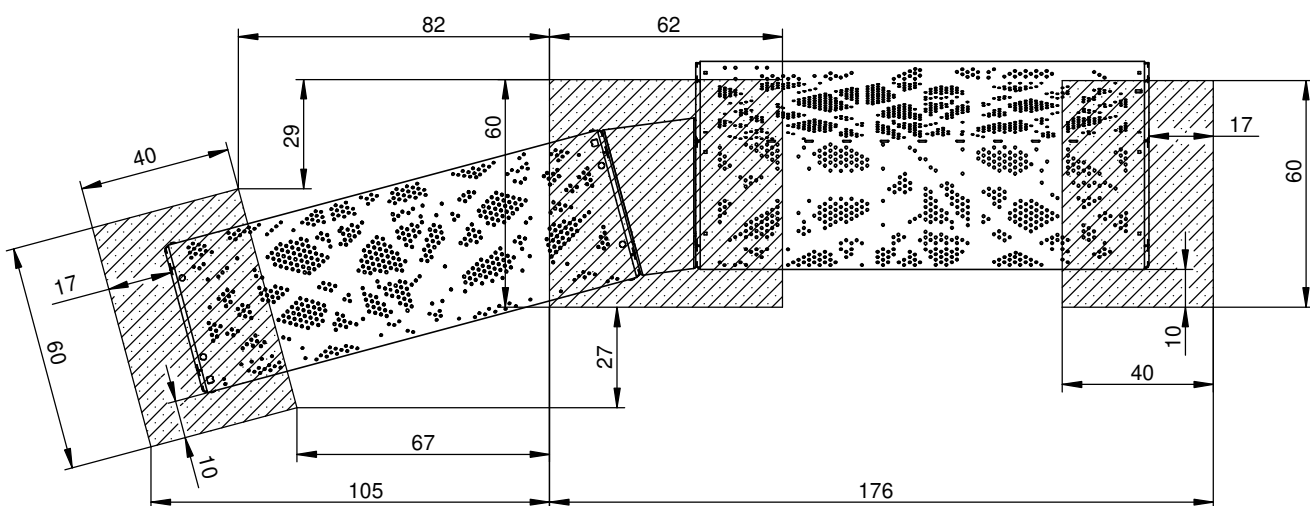
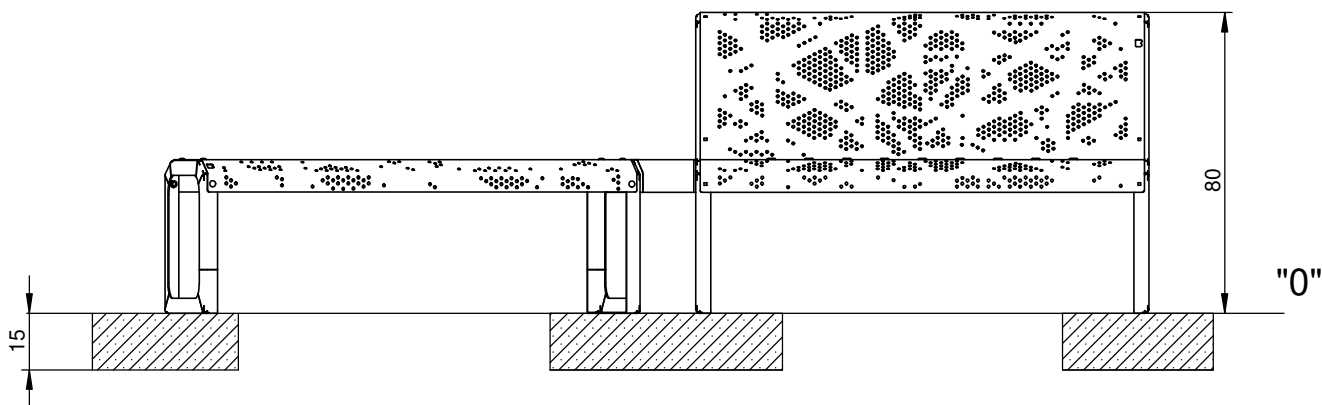
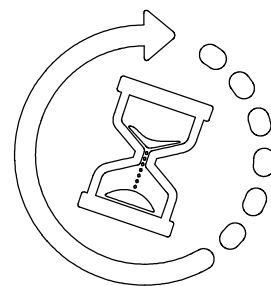
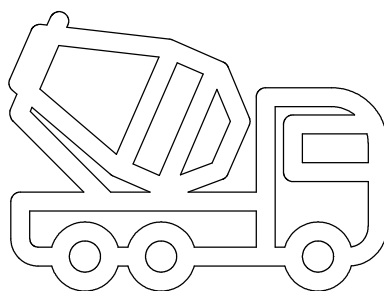
min. 48H



6114F

Nr	Element		
57		DIN 1587	M10
61		-	KL105 (OC)

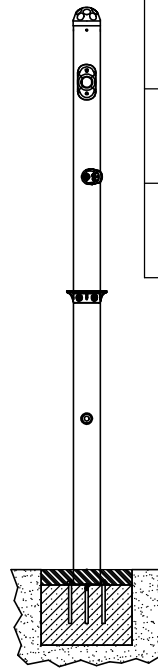
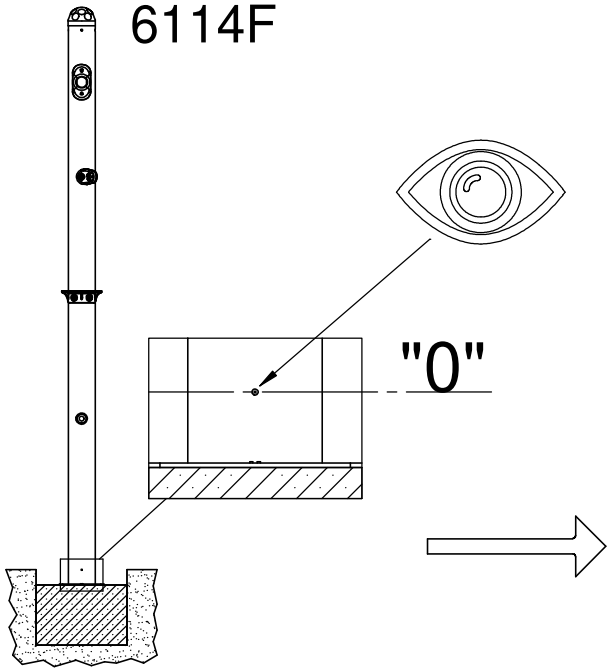

I

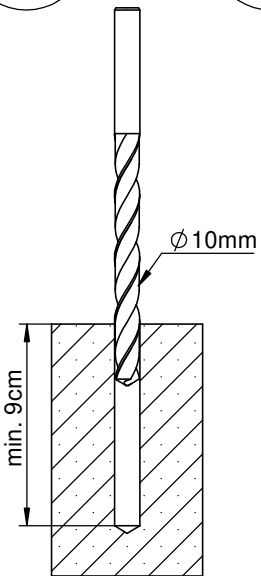

II

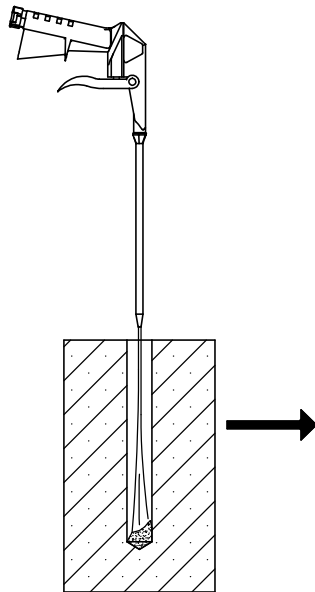

III

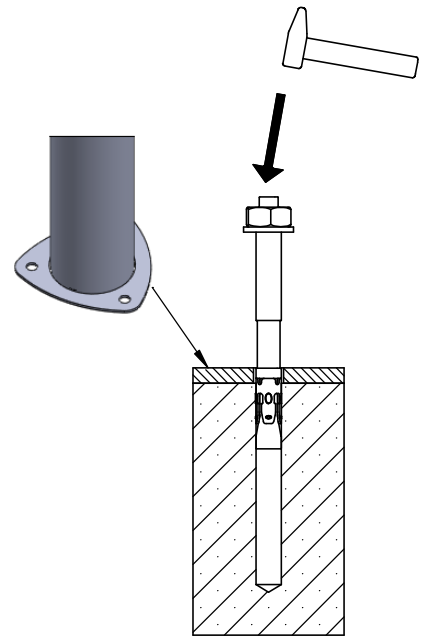

IV

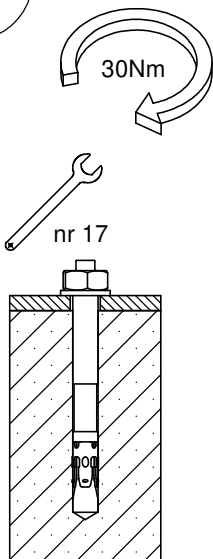

V

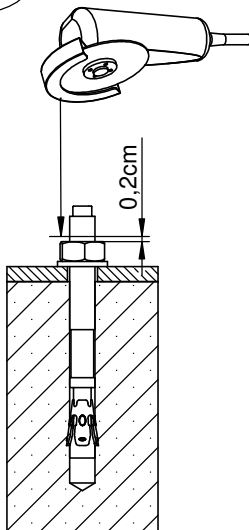

VI

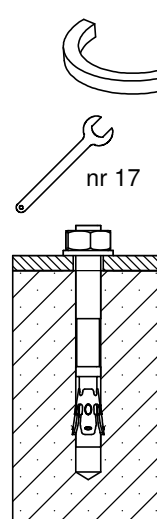

VII

