

8453N

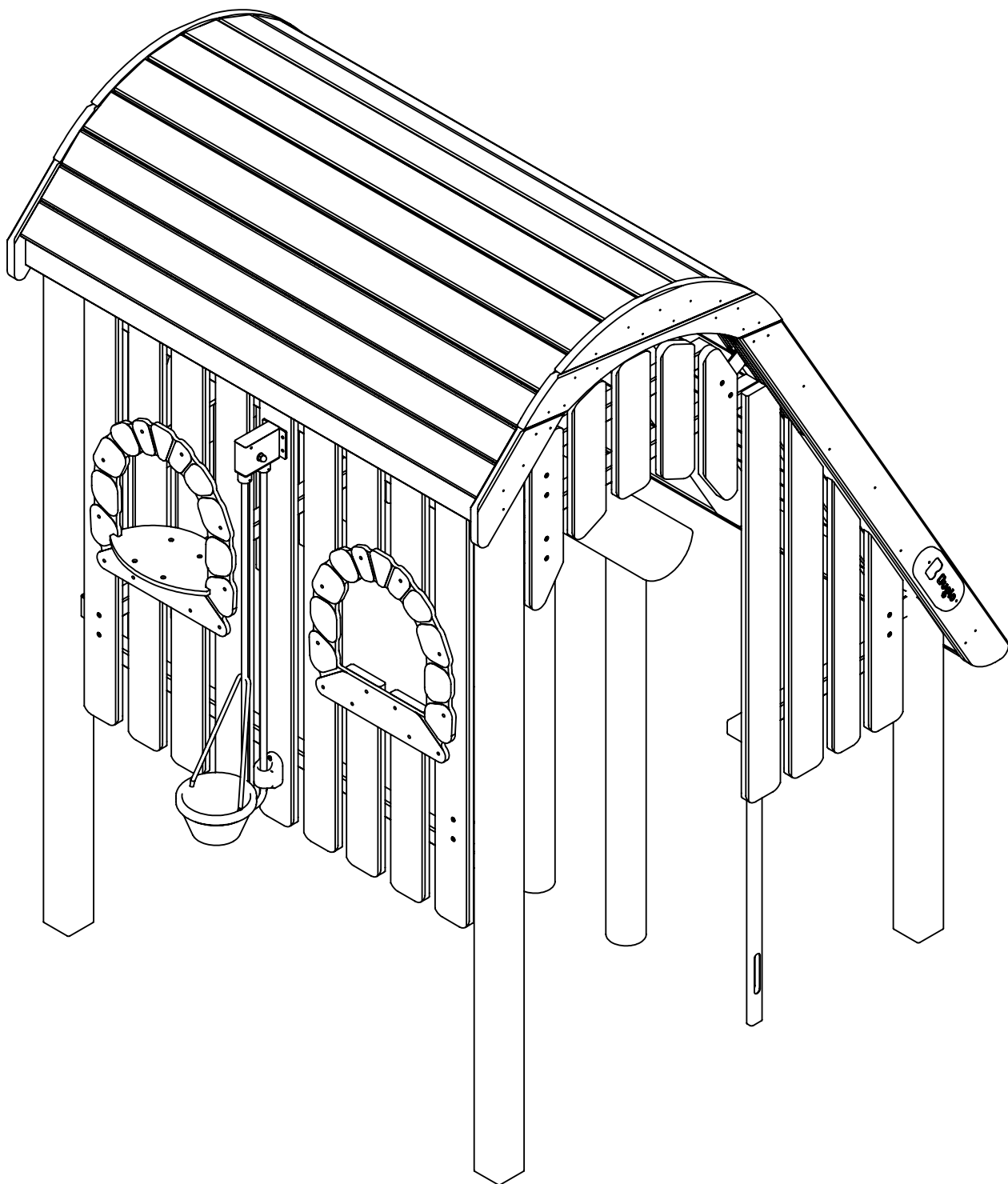

8453N

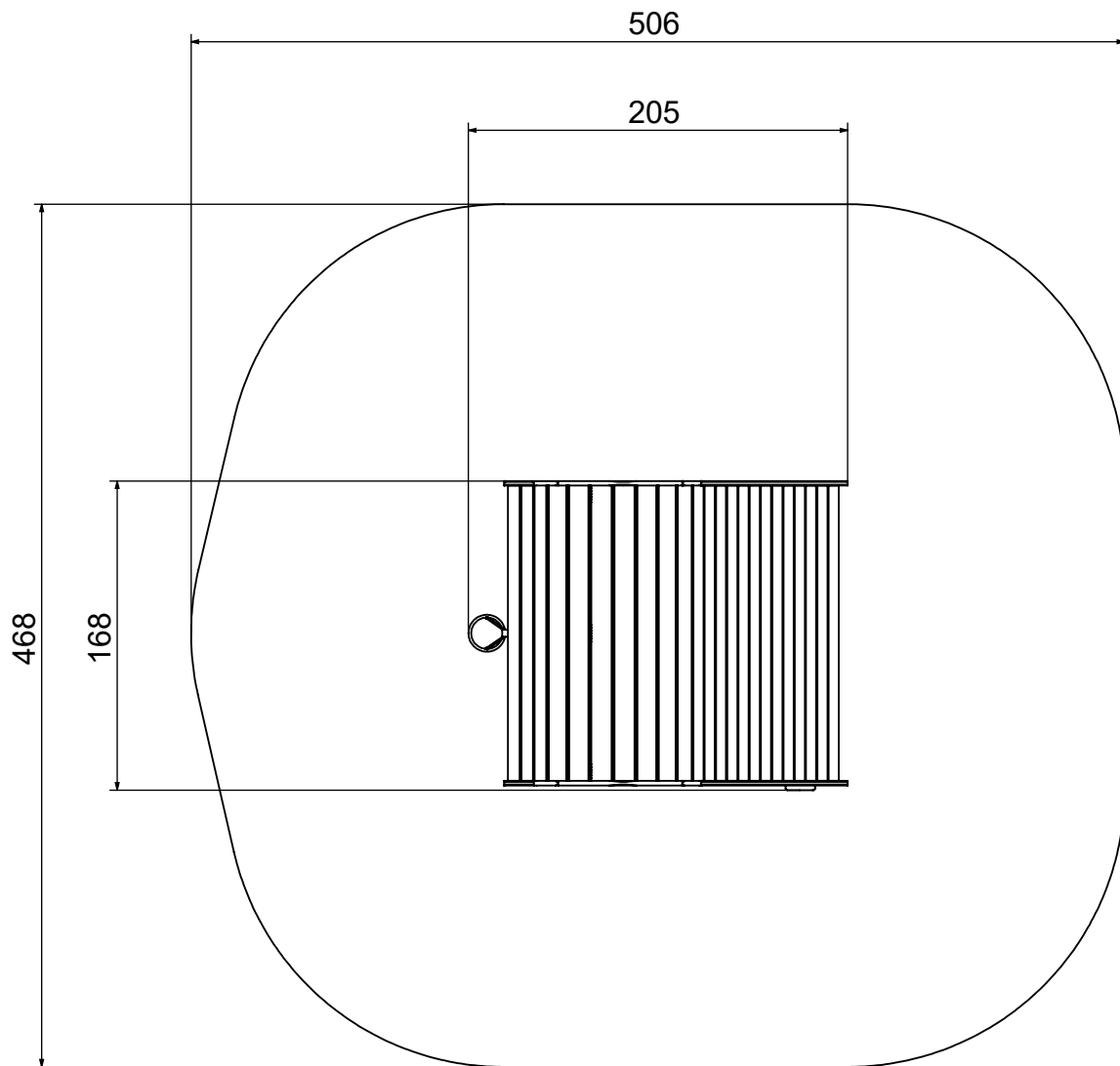
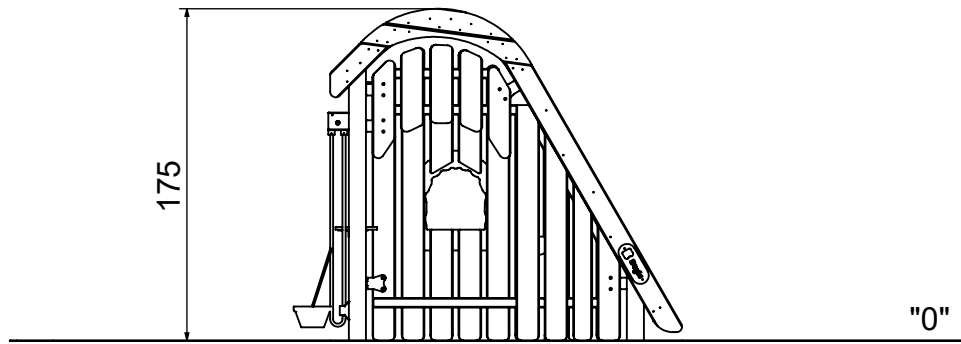

8453N

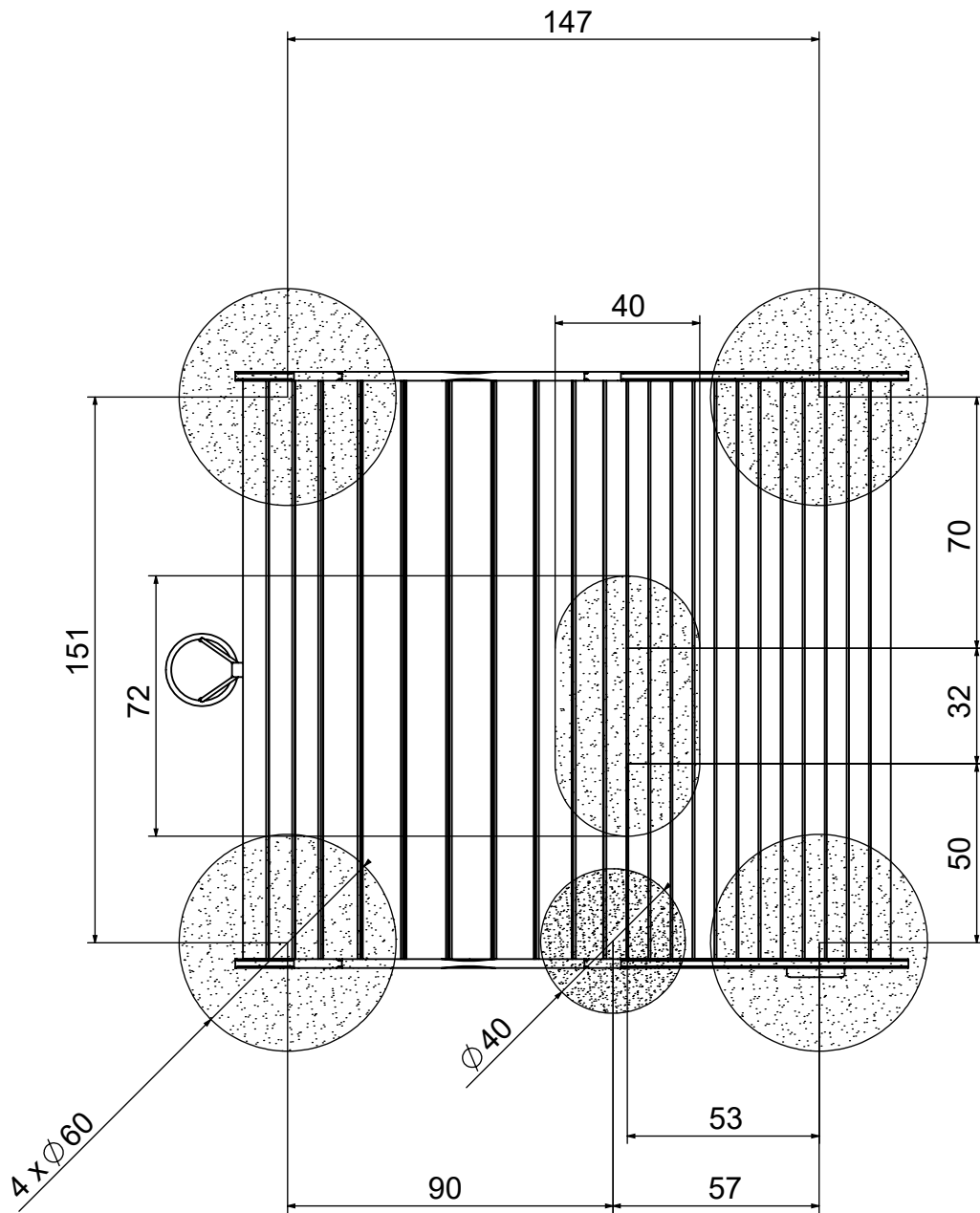
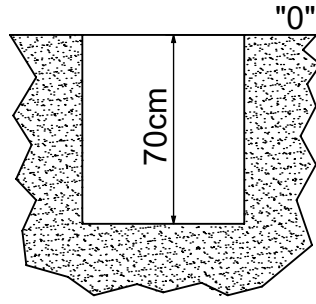

8453N

3
B25 0,48m

min. 48H

