

8455N

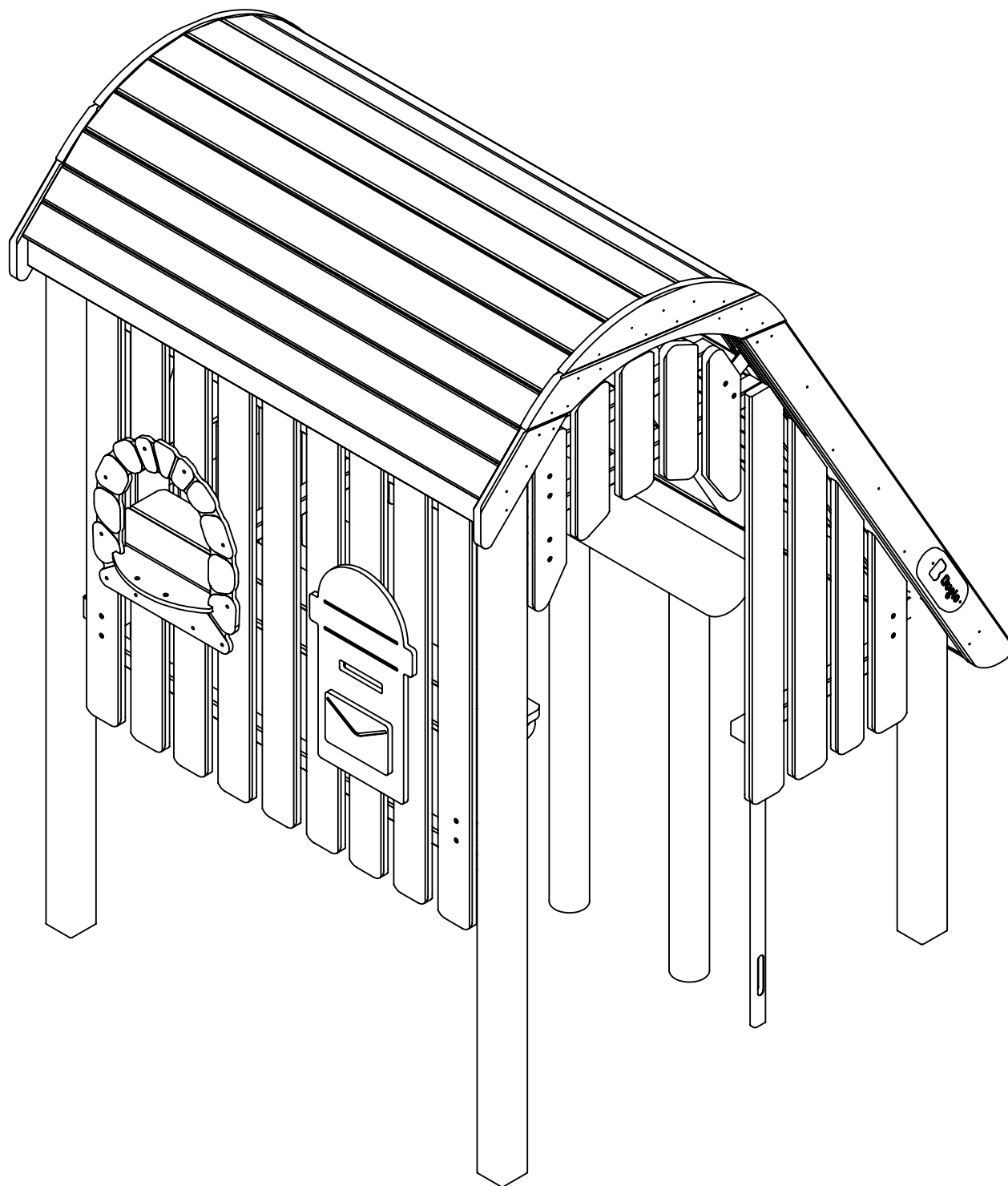

8455N

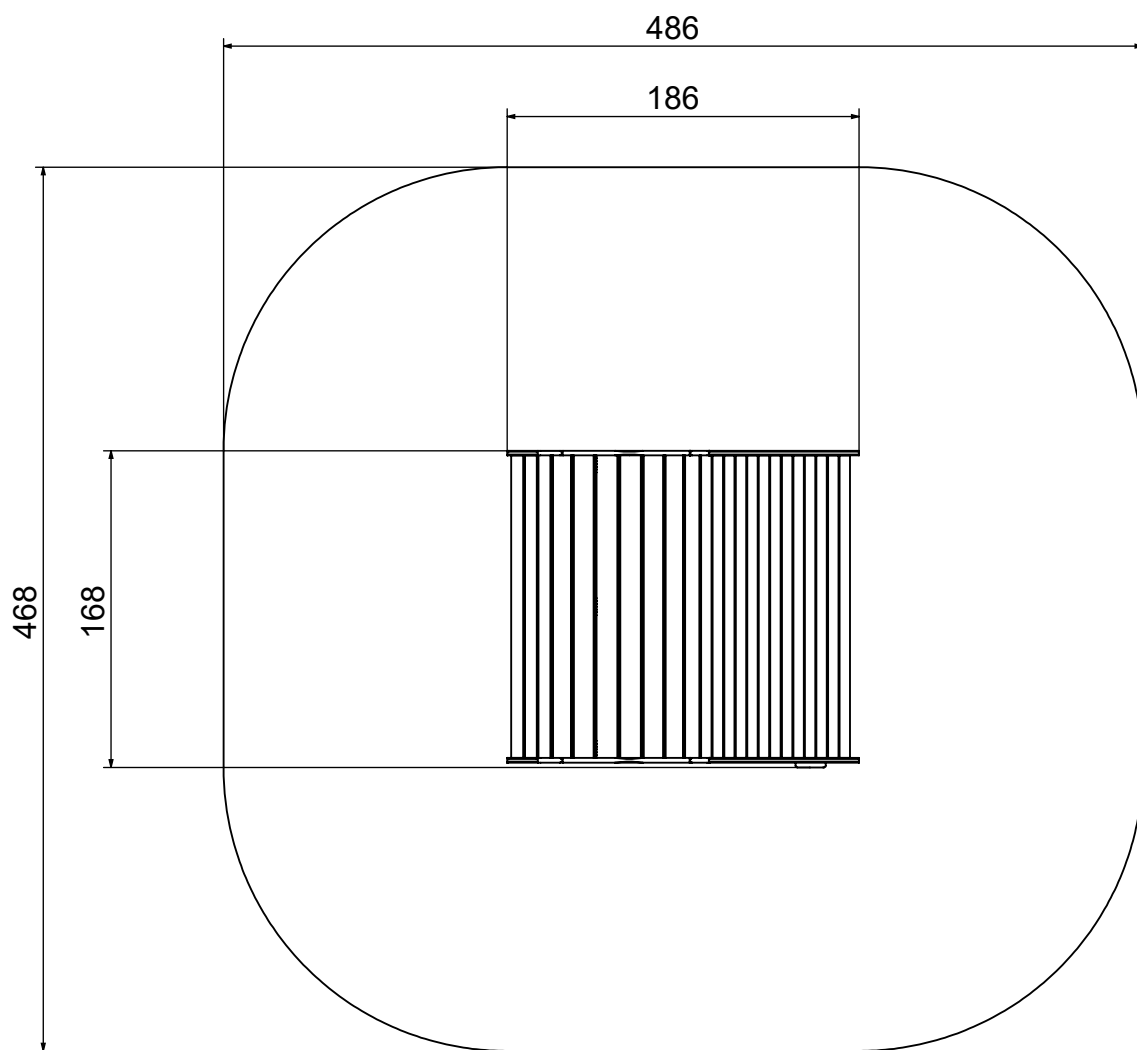
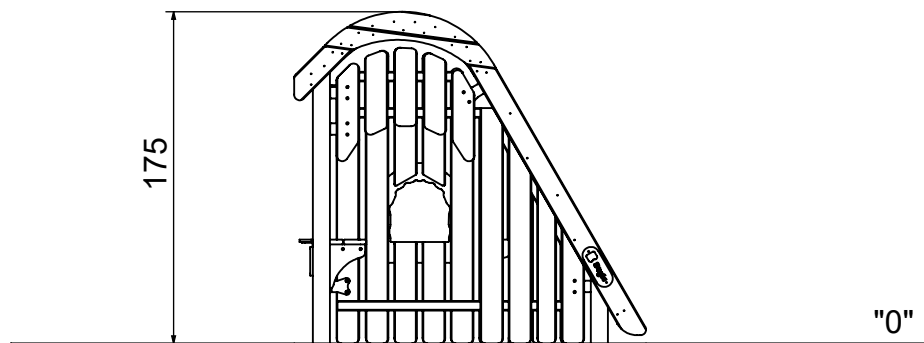

8455N

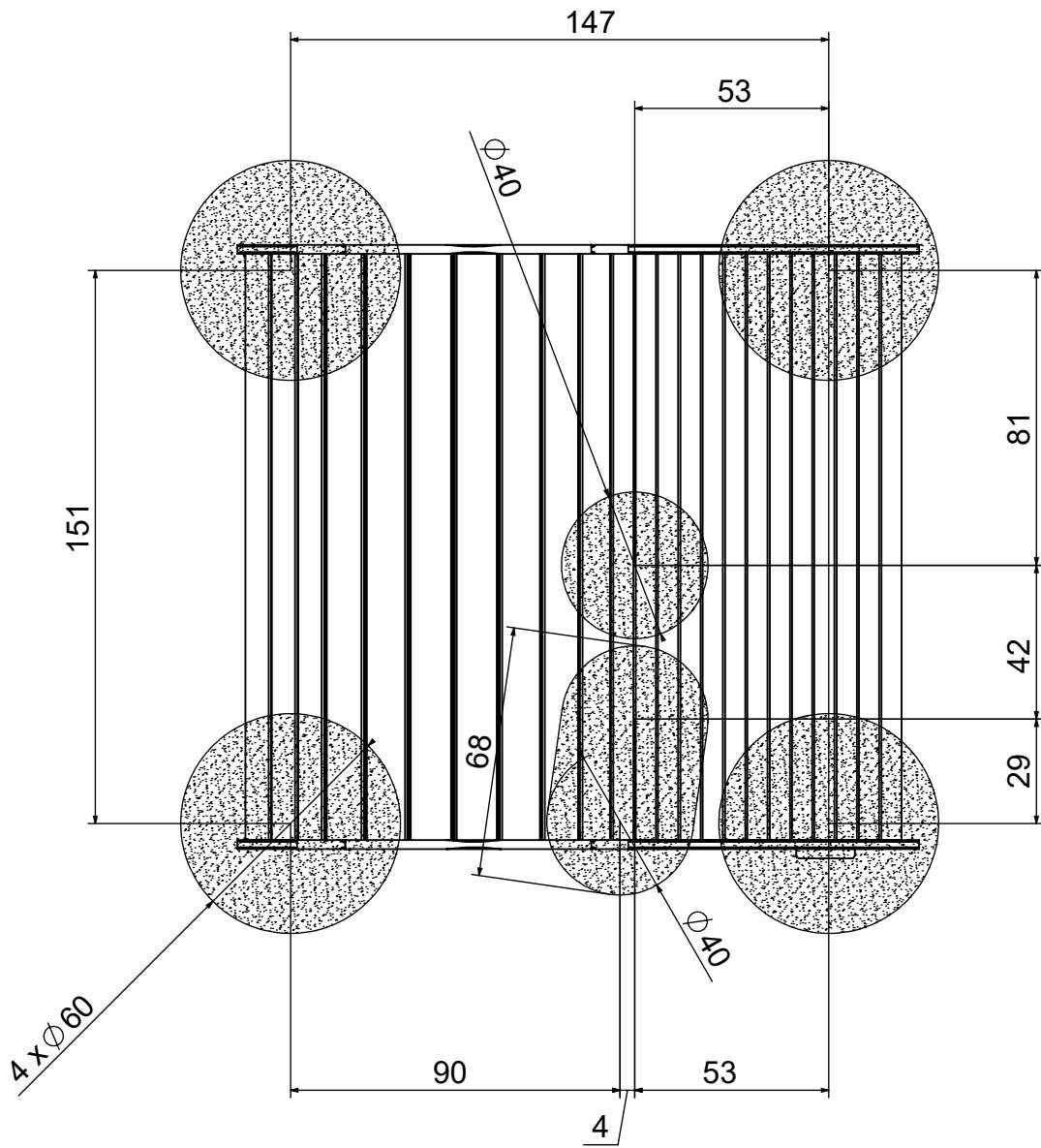
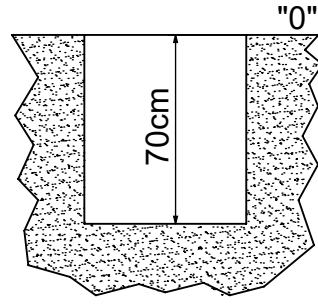

8455N

3
B25 0,48m

min. 48H

