

8457N

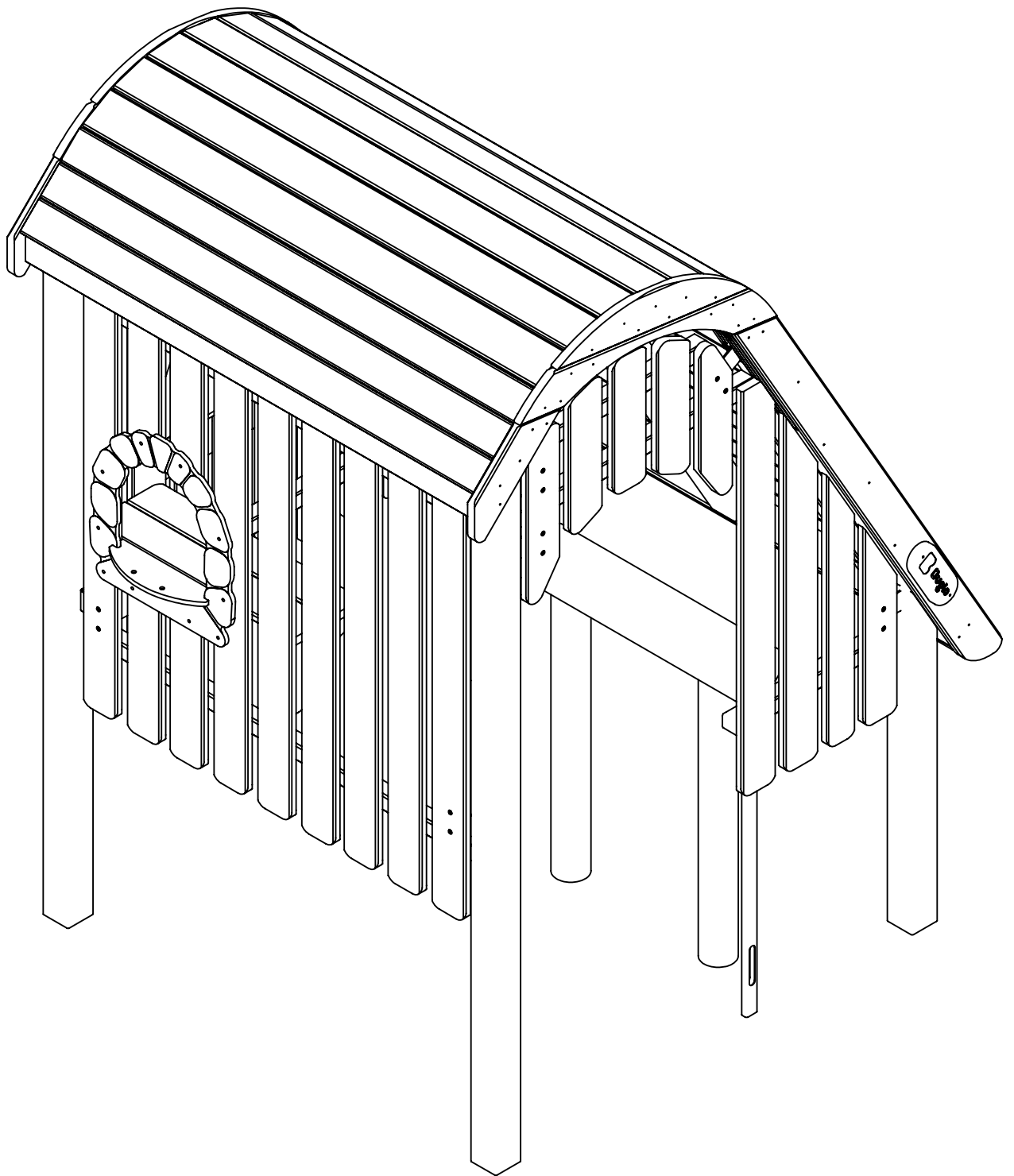

8457N

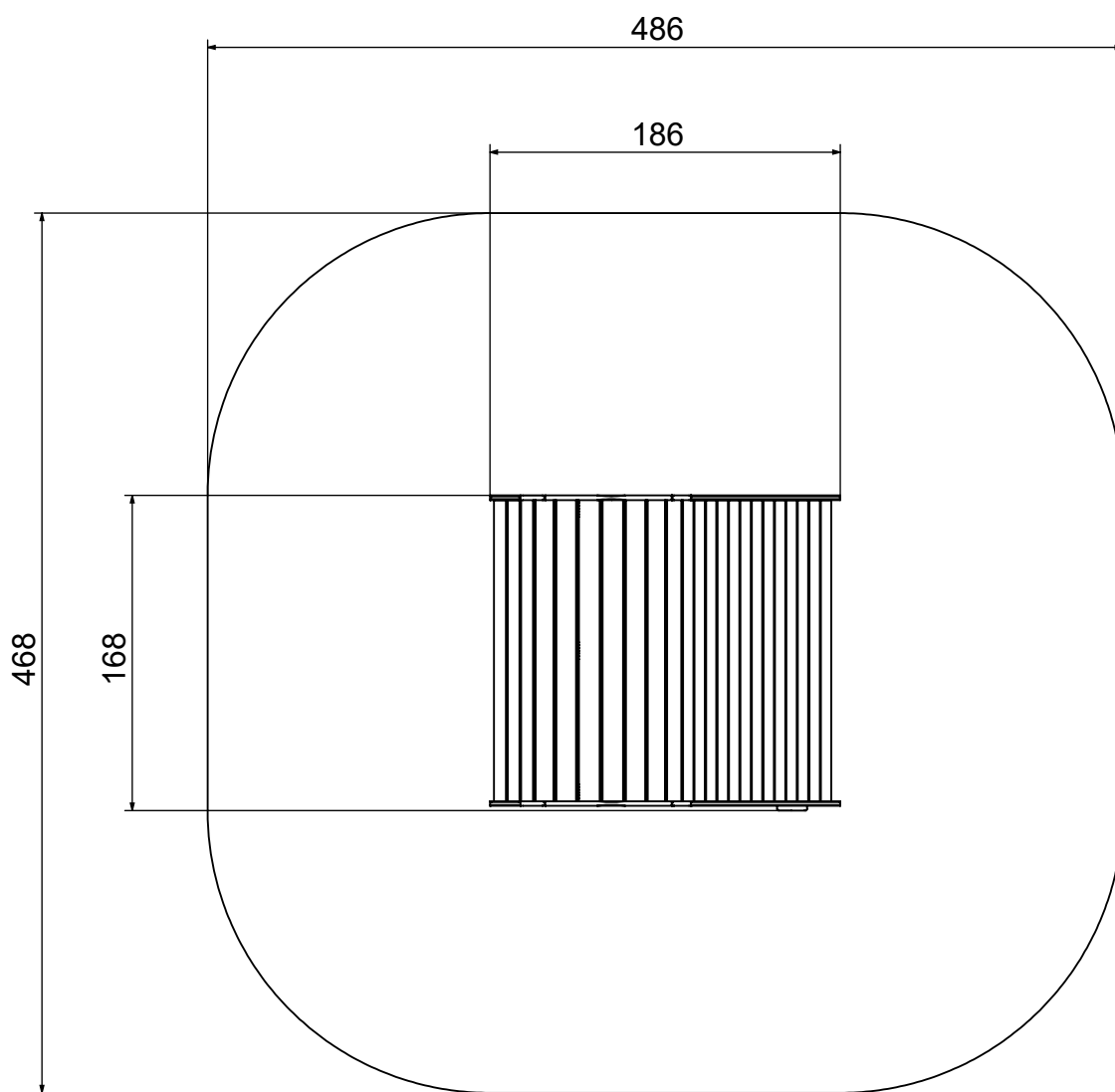
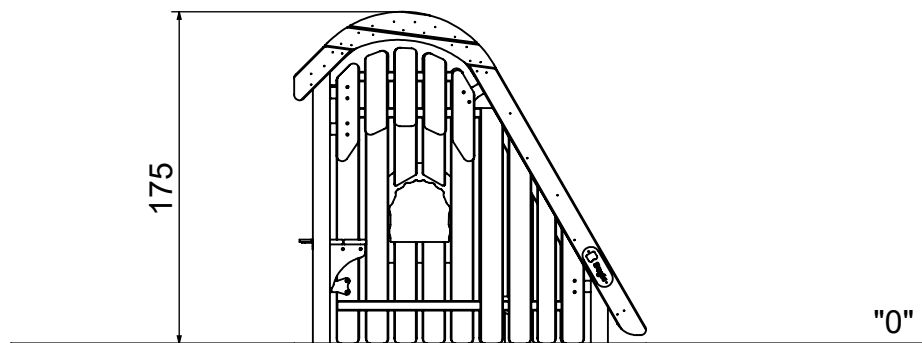

8457N

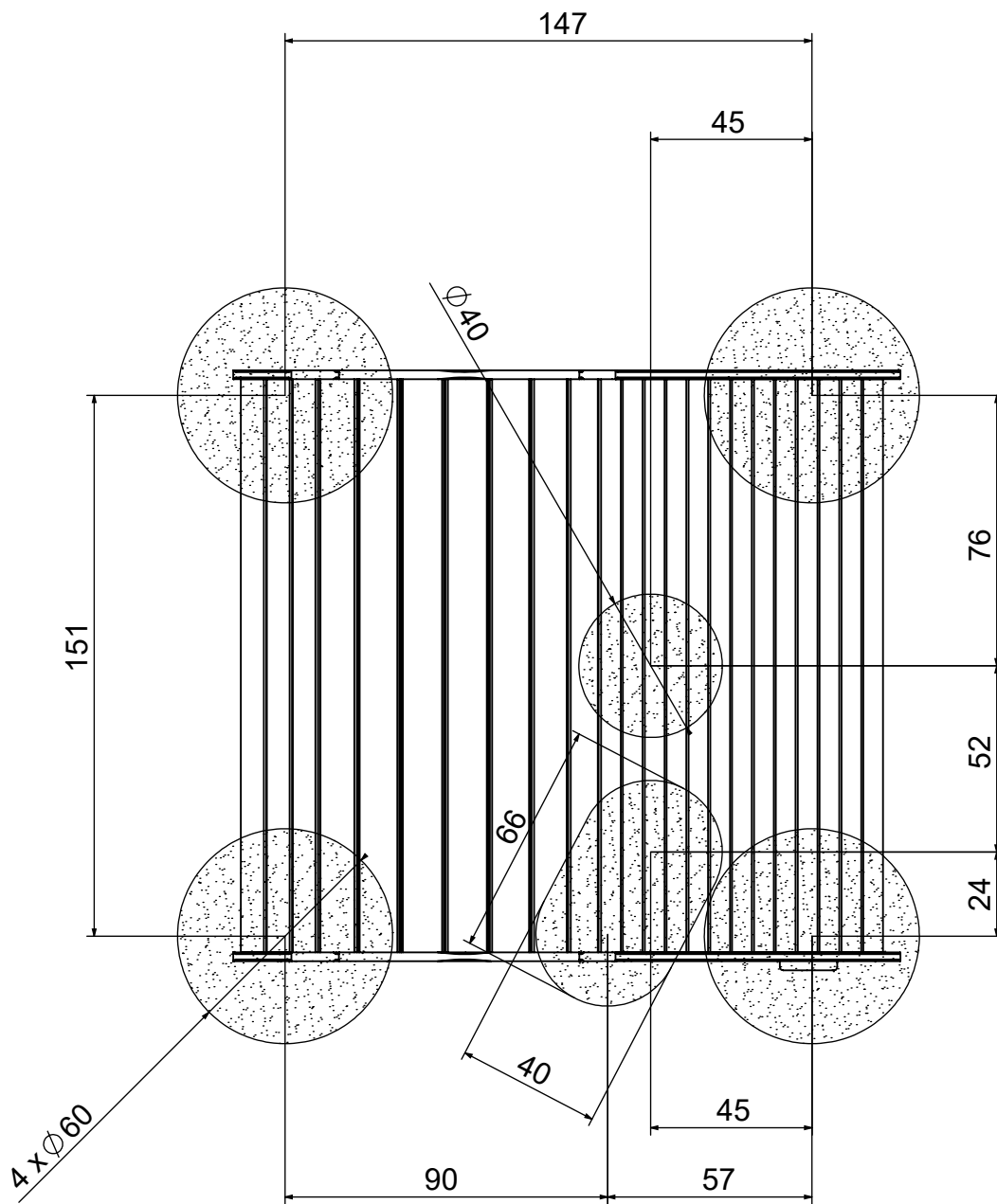
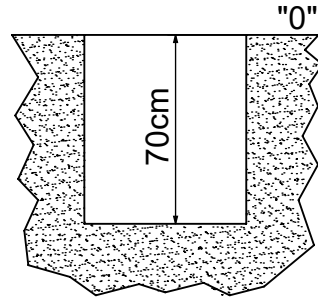

8457N

3
B25 0,48m

min. 48H

