

8460N

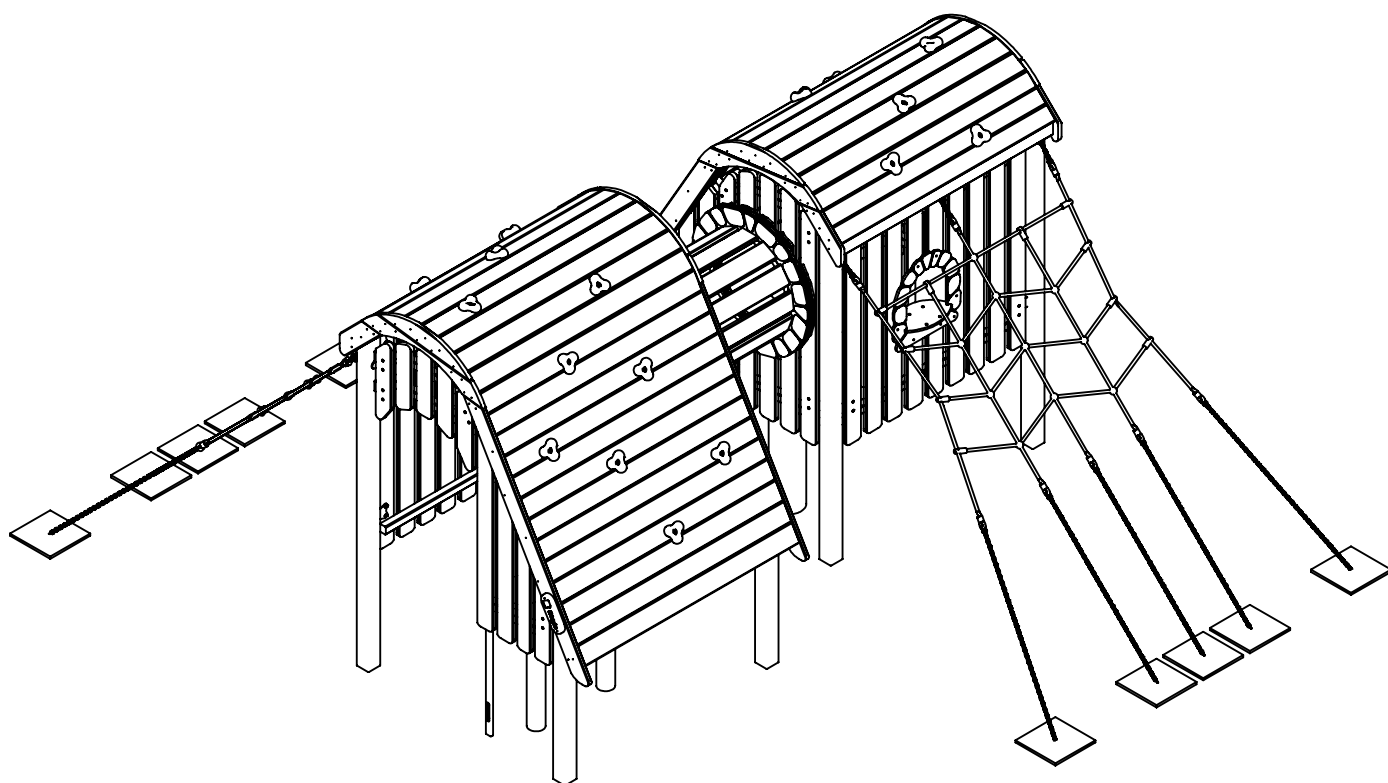

8460N

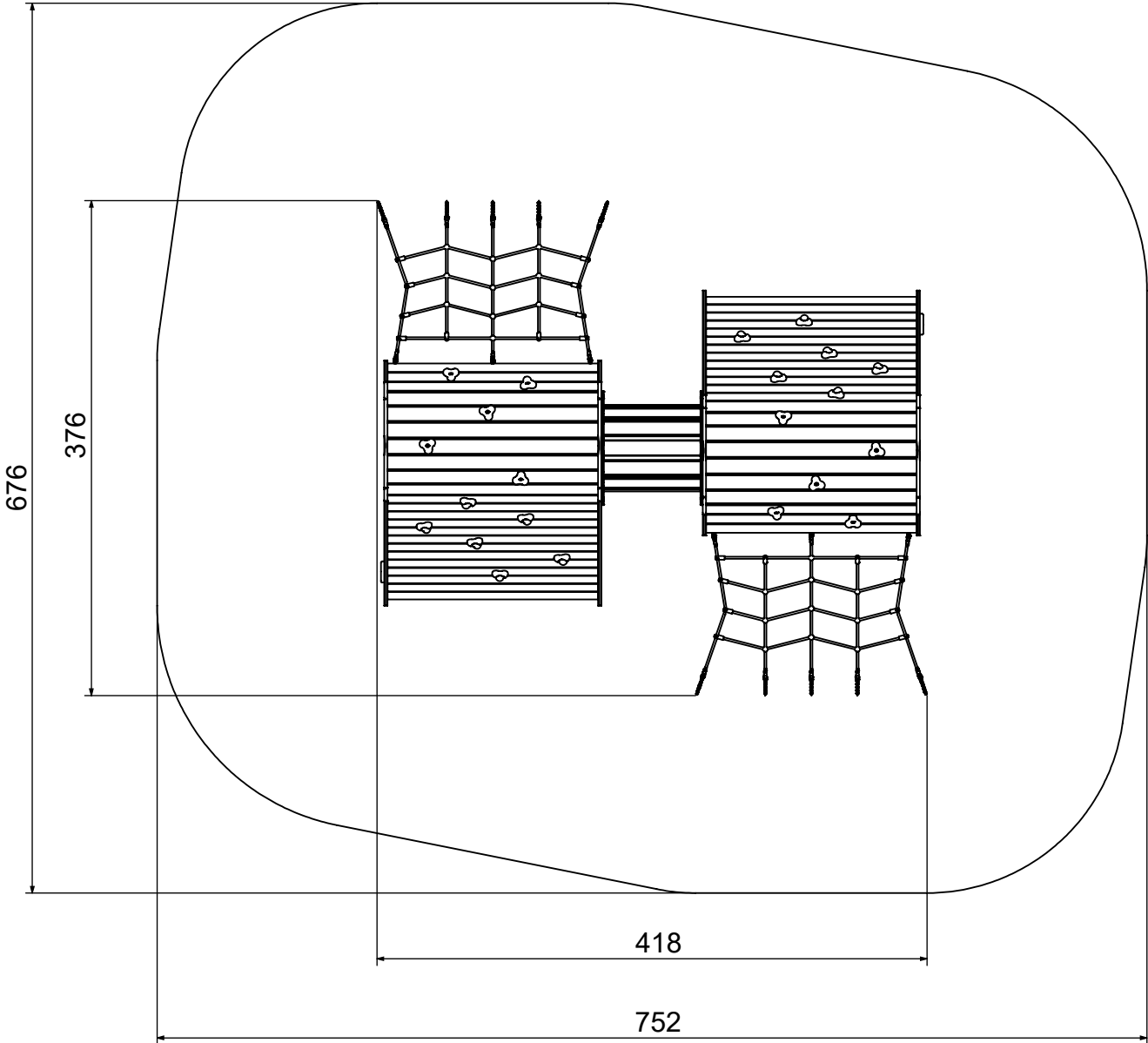
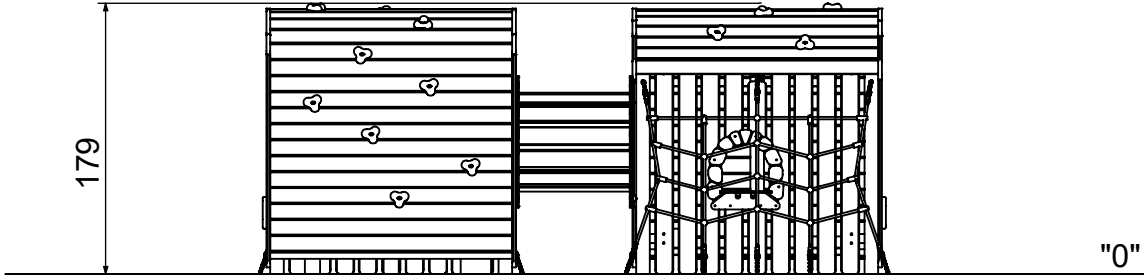

8460N

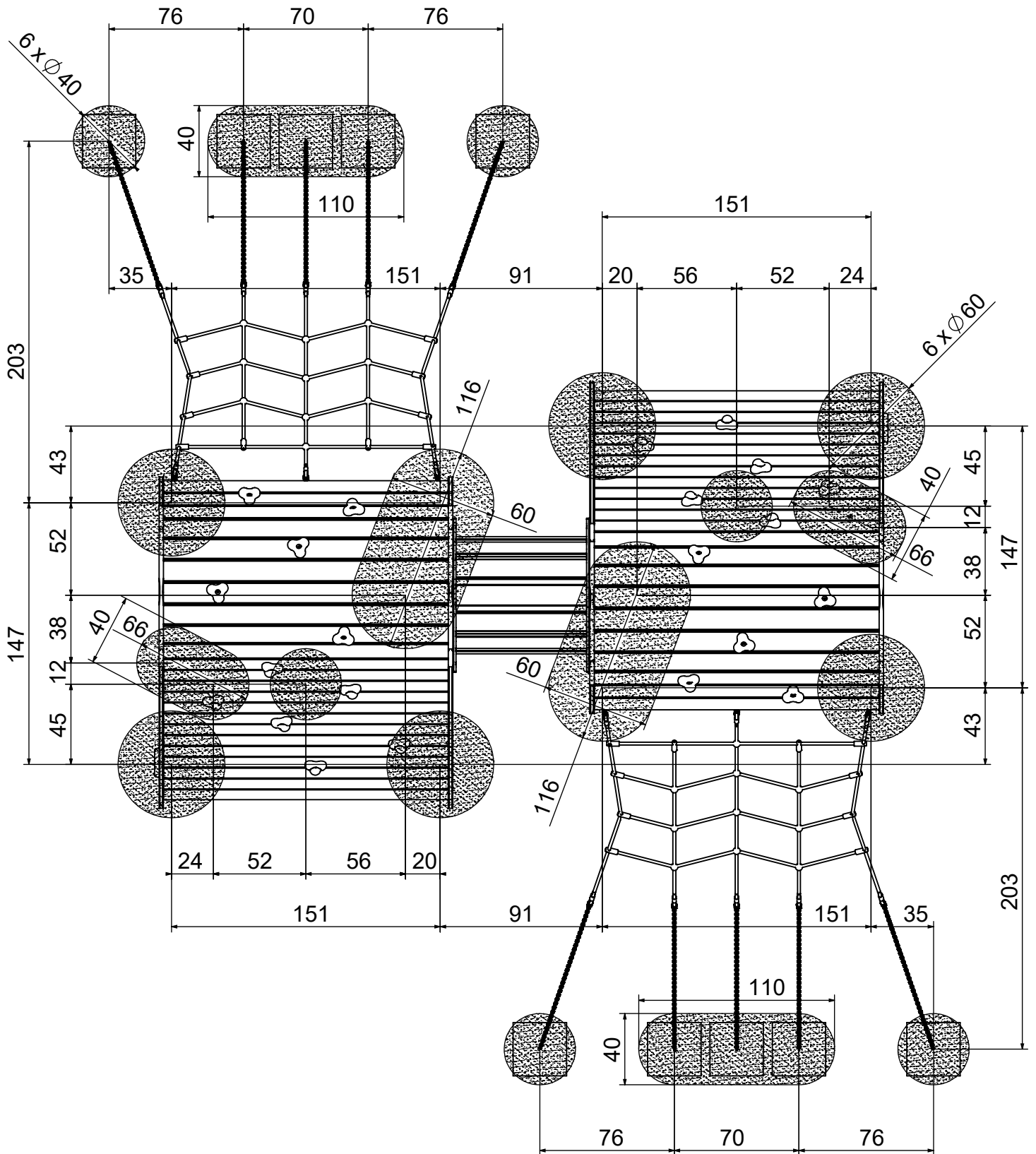
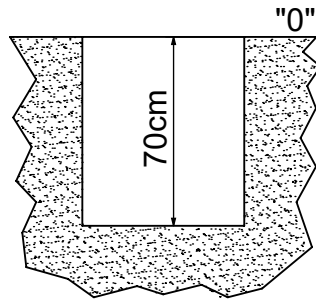

8460N

B25 1,7m³

min. 48H

