

8461N

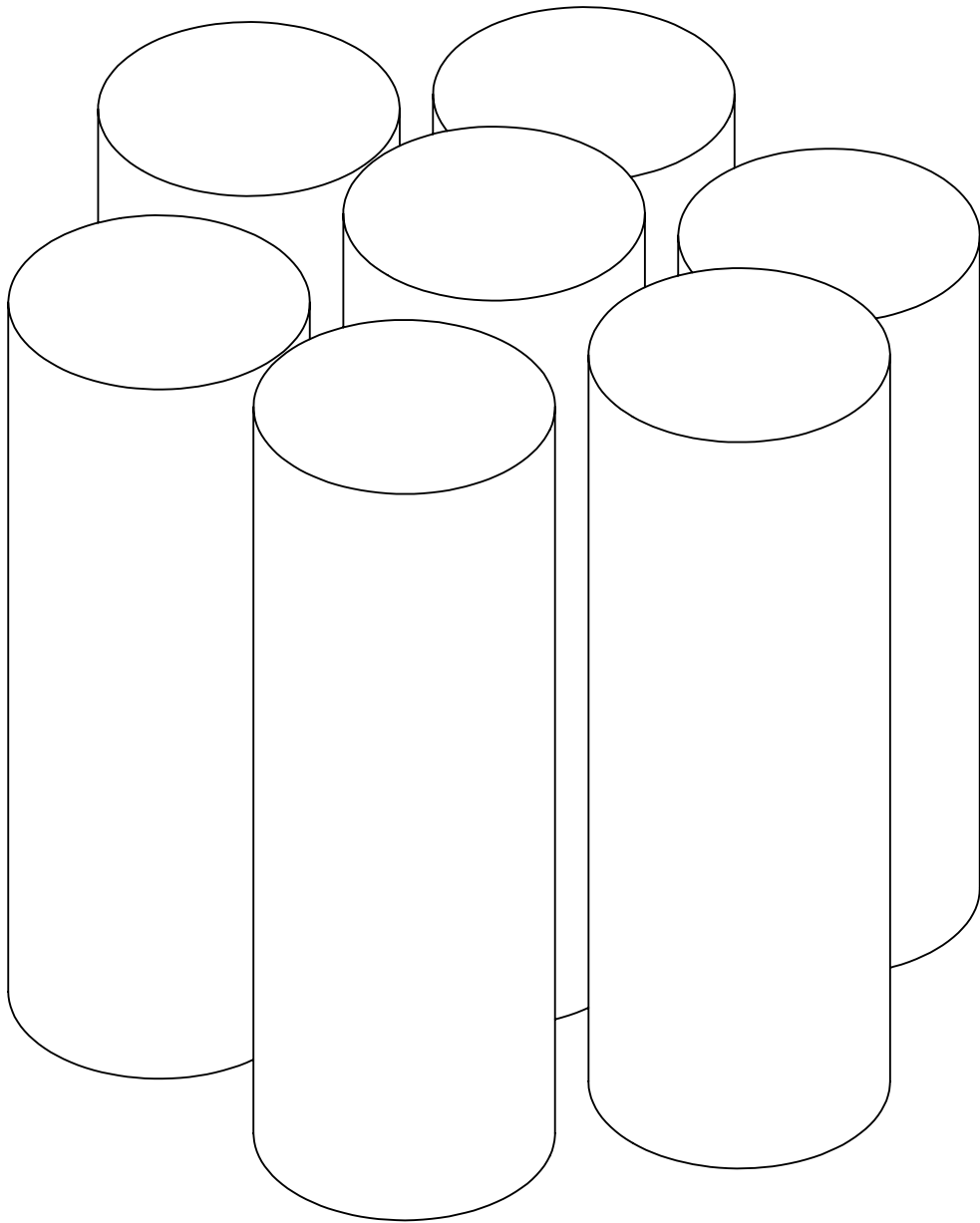

8461N

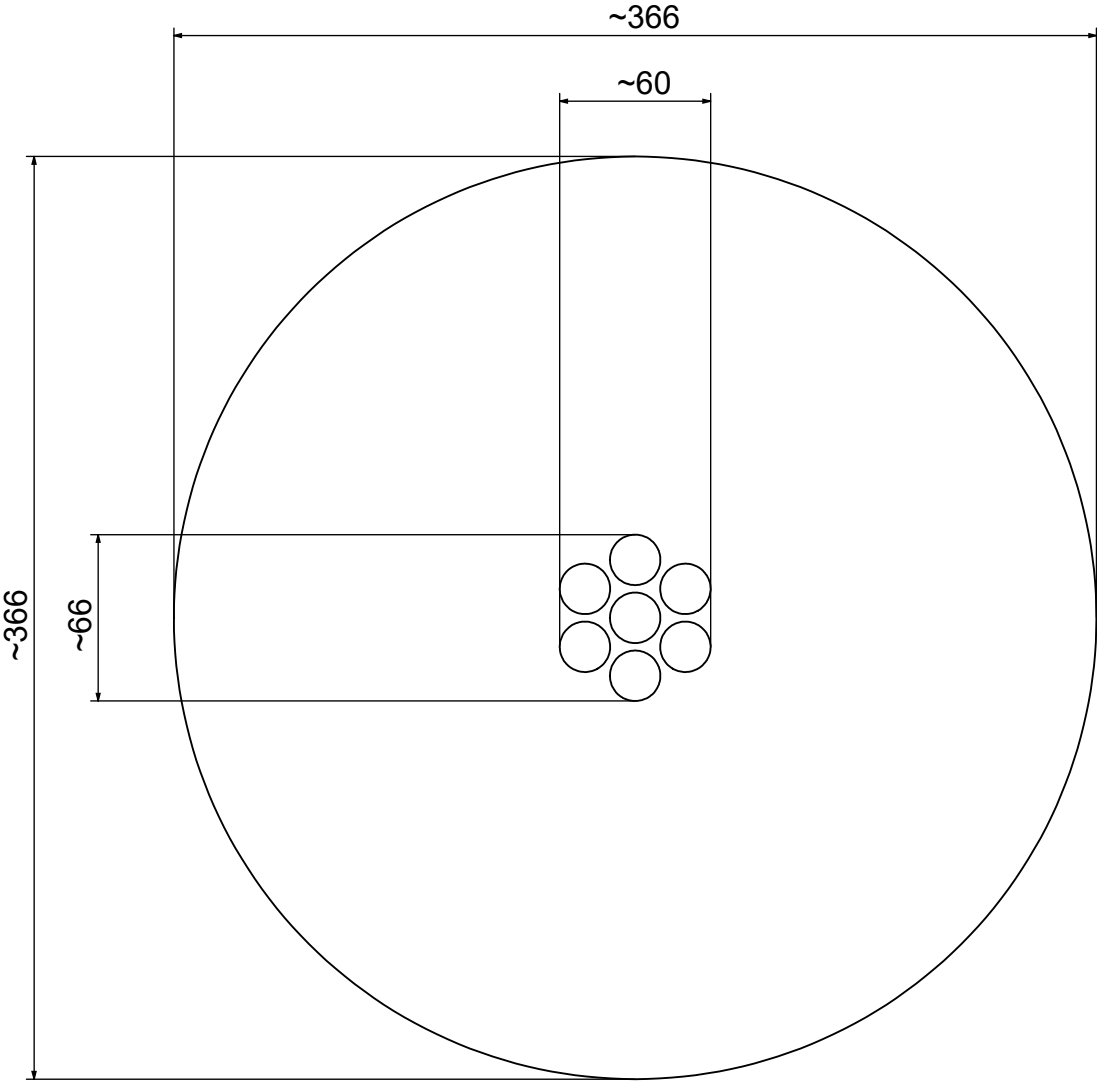

8461N

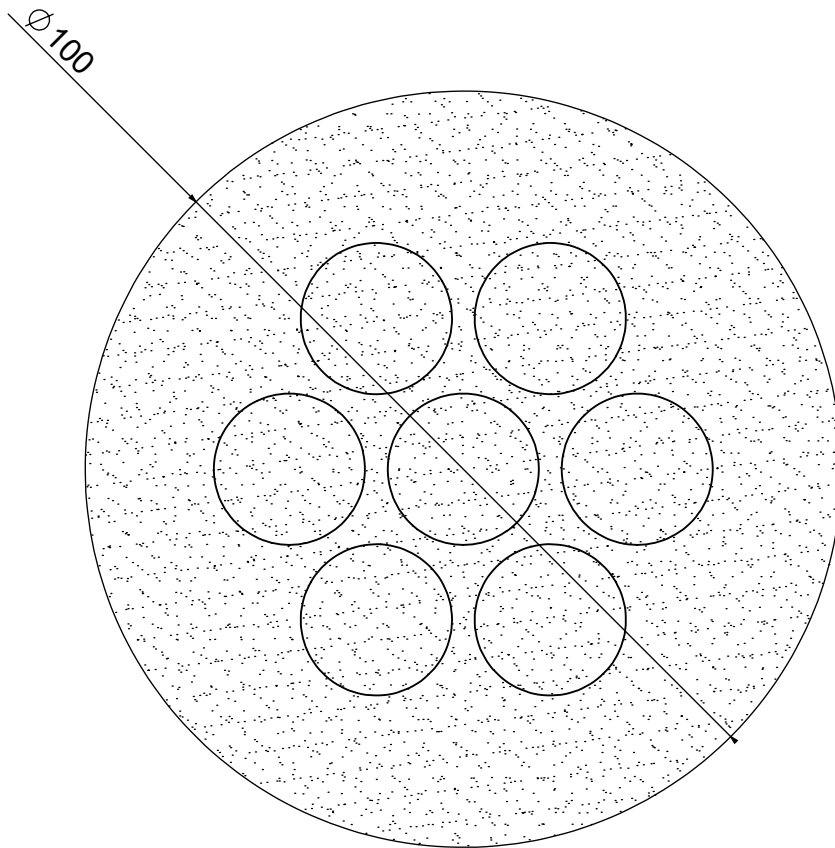
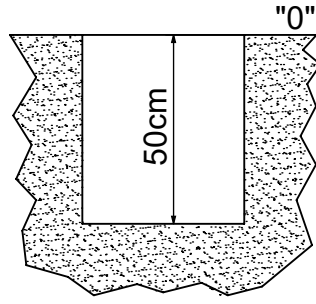

8461N

B25 0,07m³

min. 48H

