

8601N

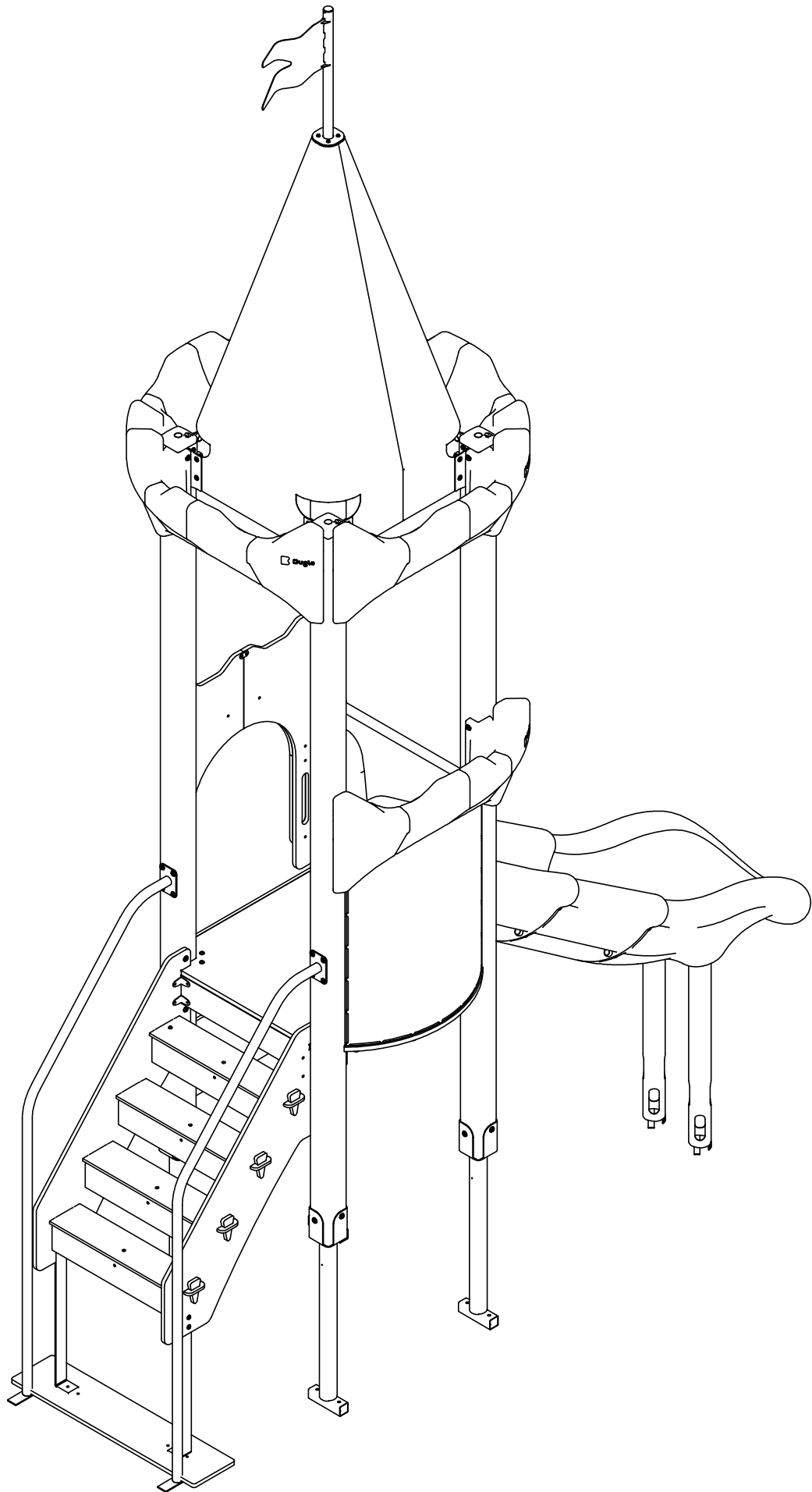

8601N

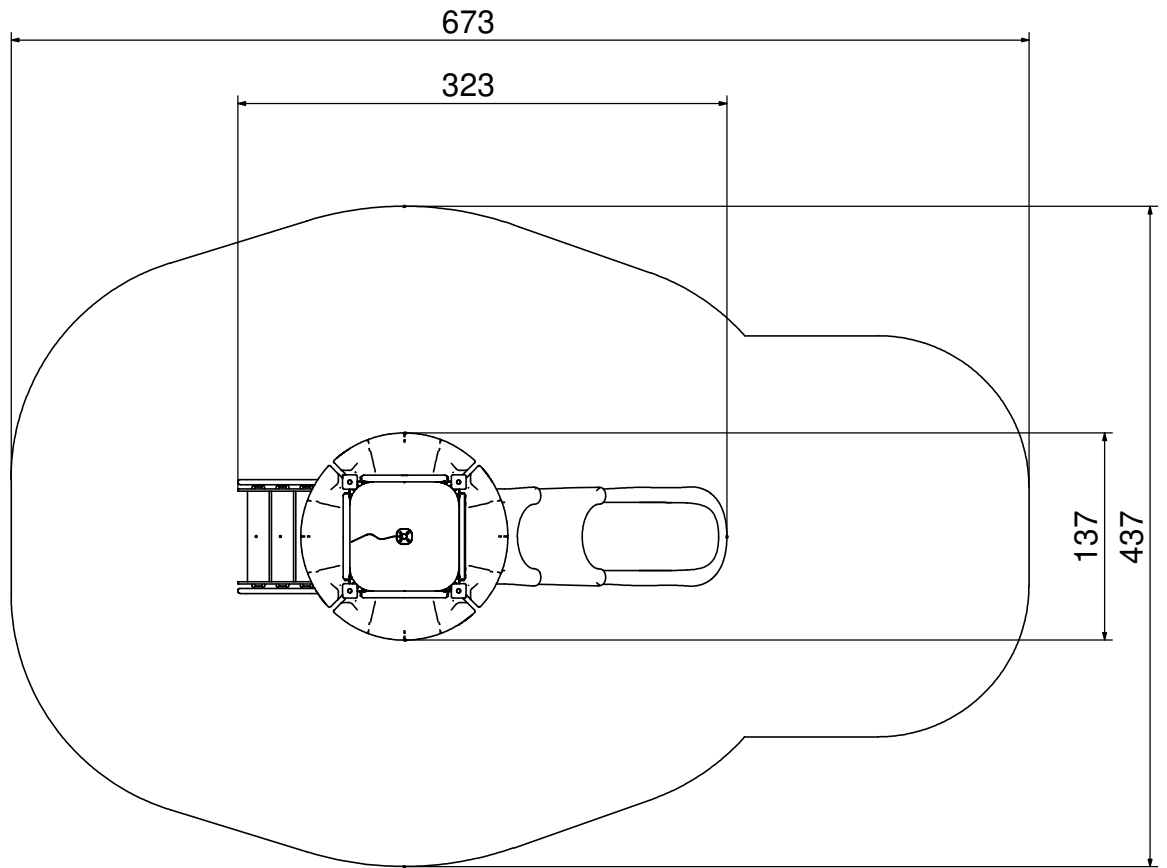
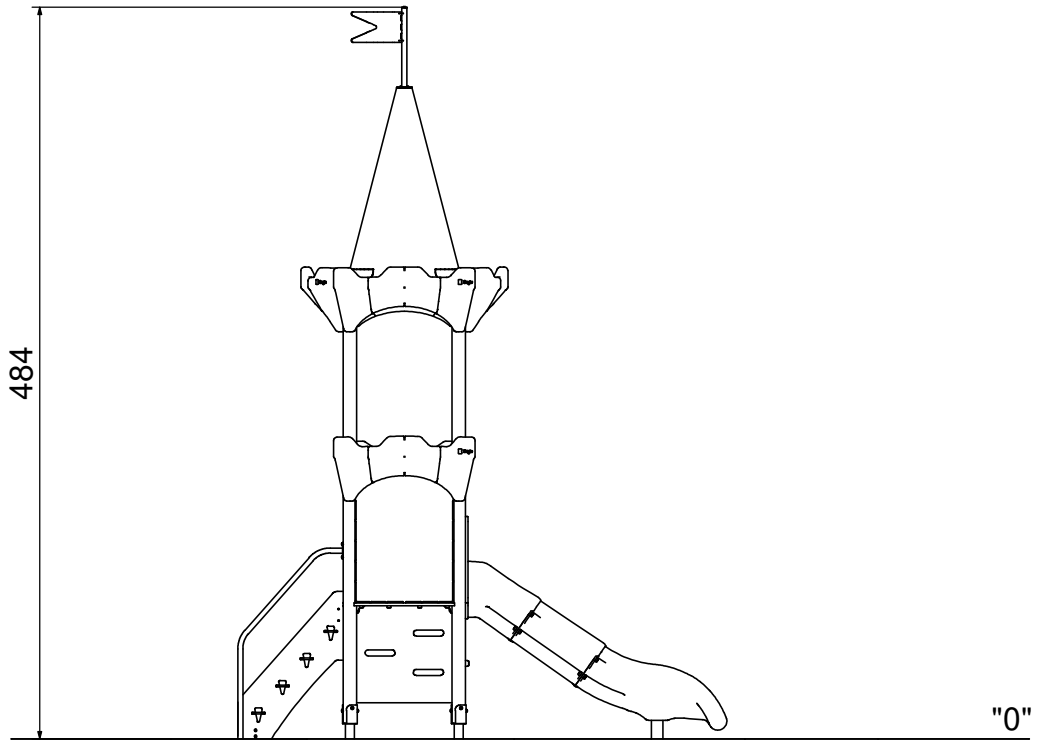

8601N

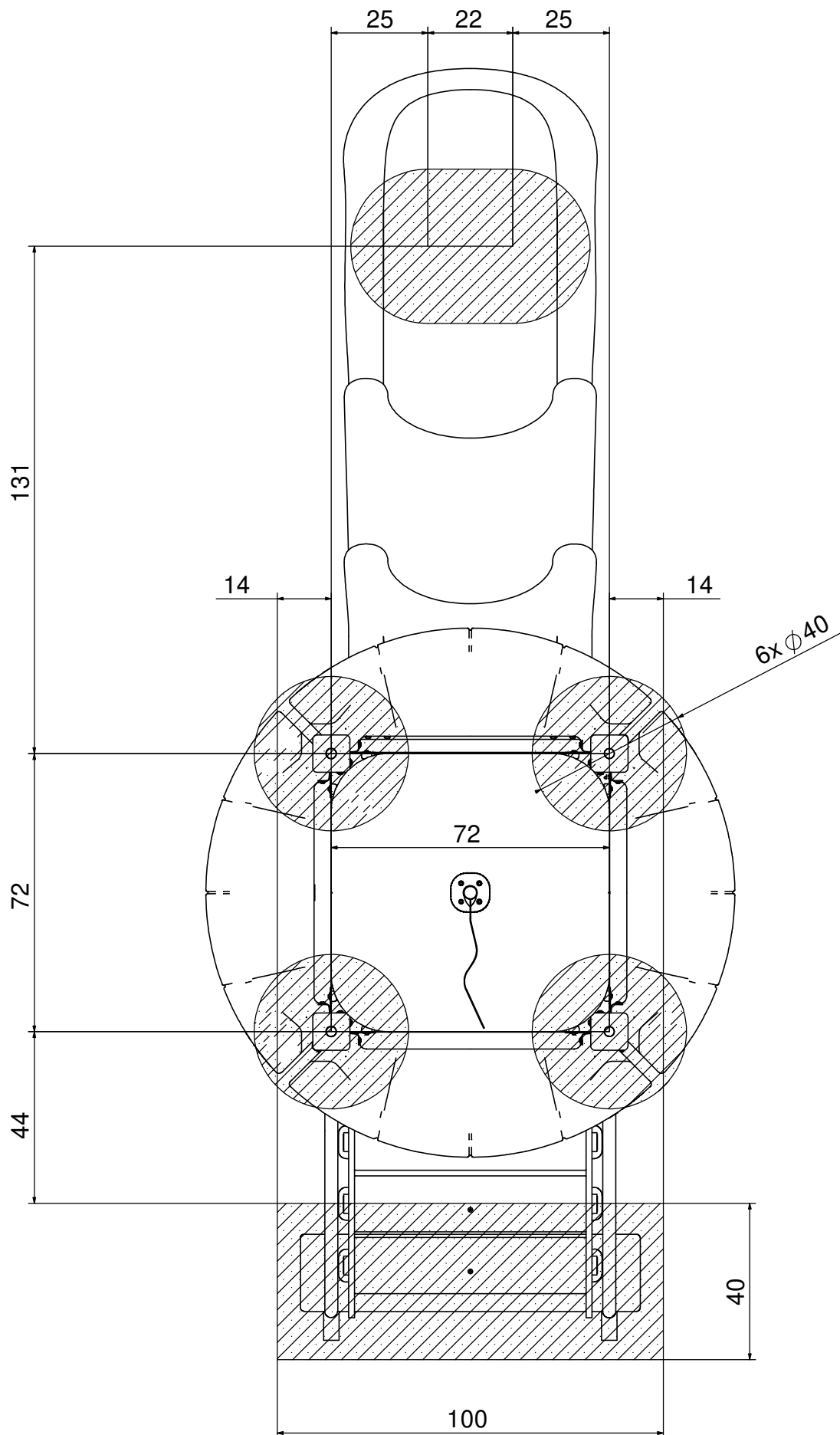

8601N

B25 0,25m³

min. 48H

