

8602N

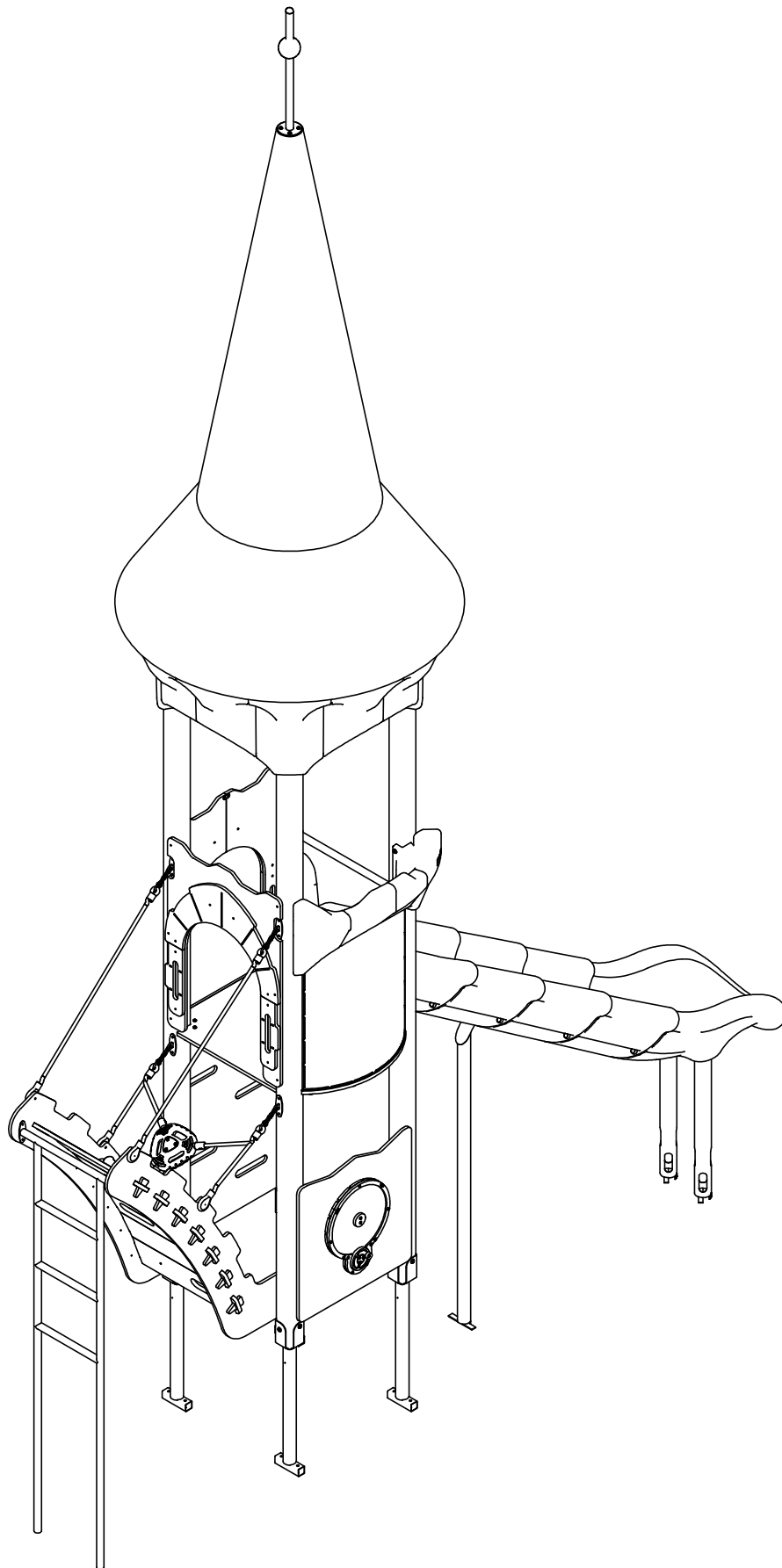

8602N

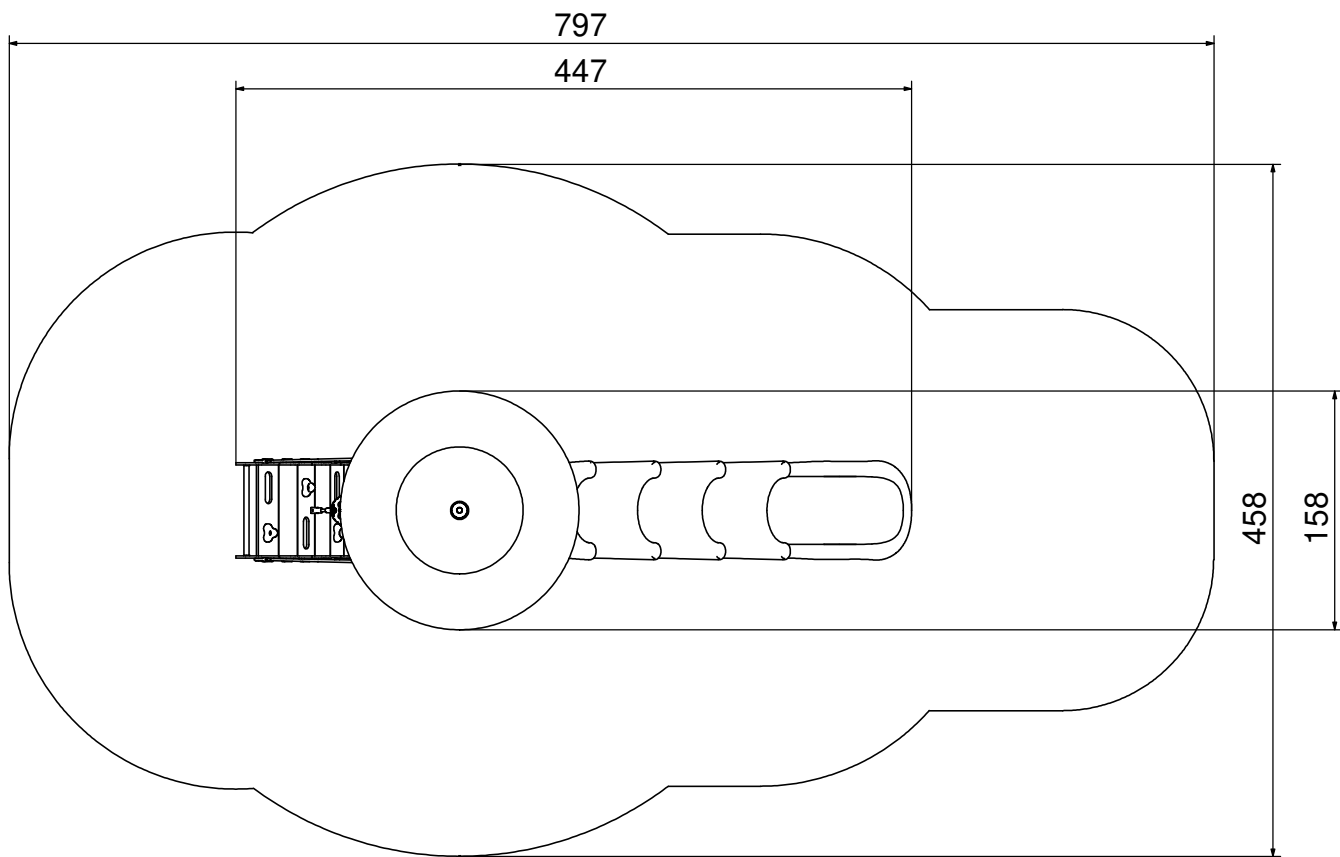
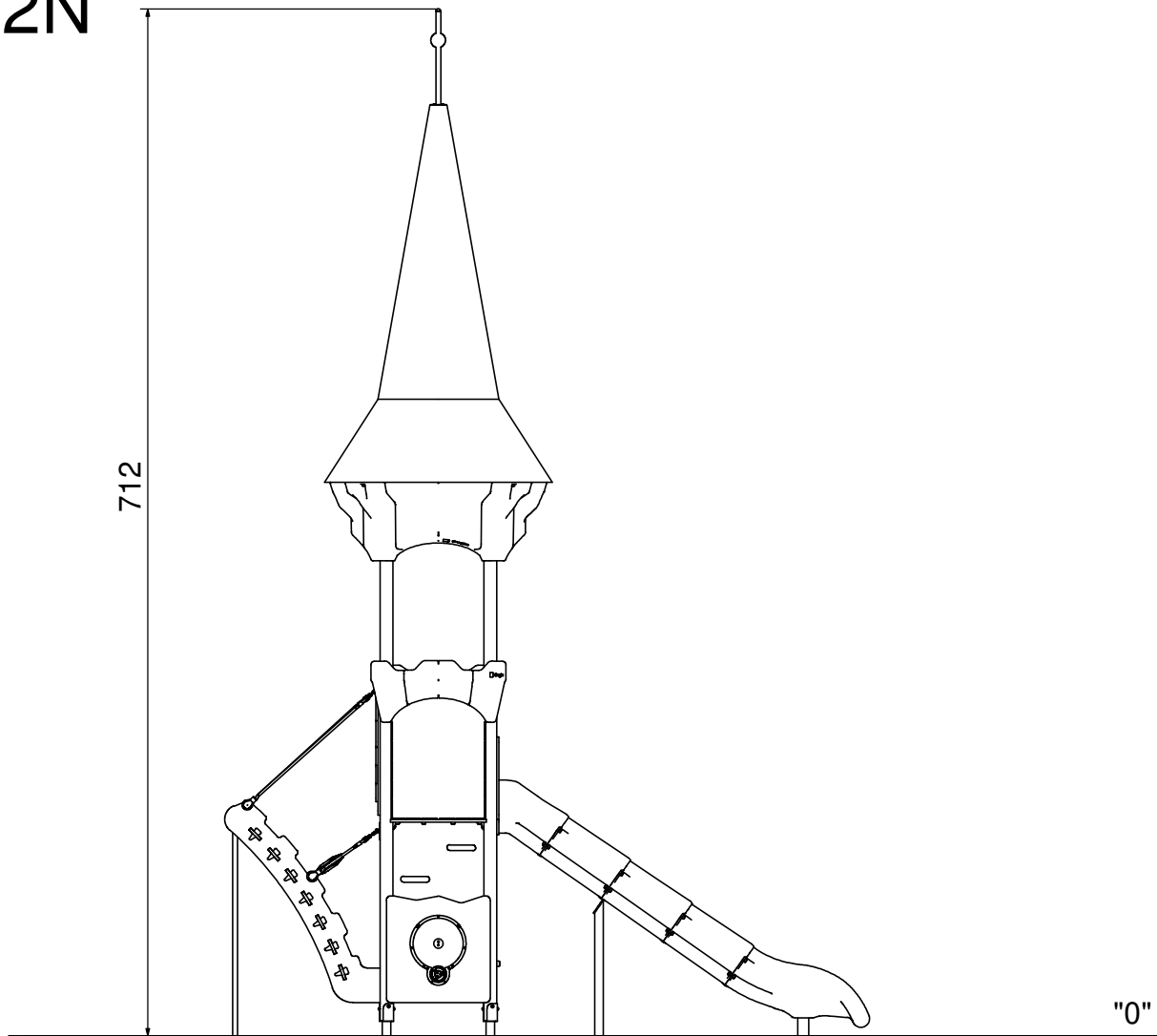

# 8602N

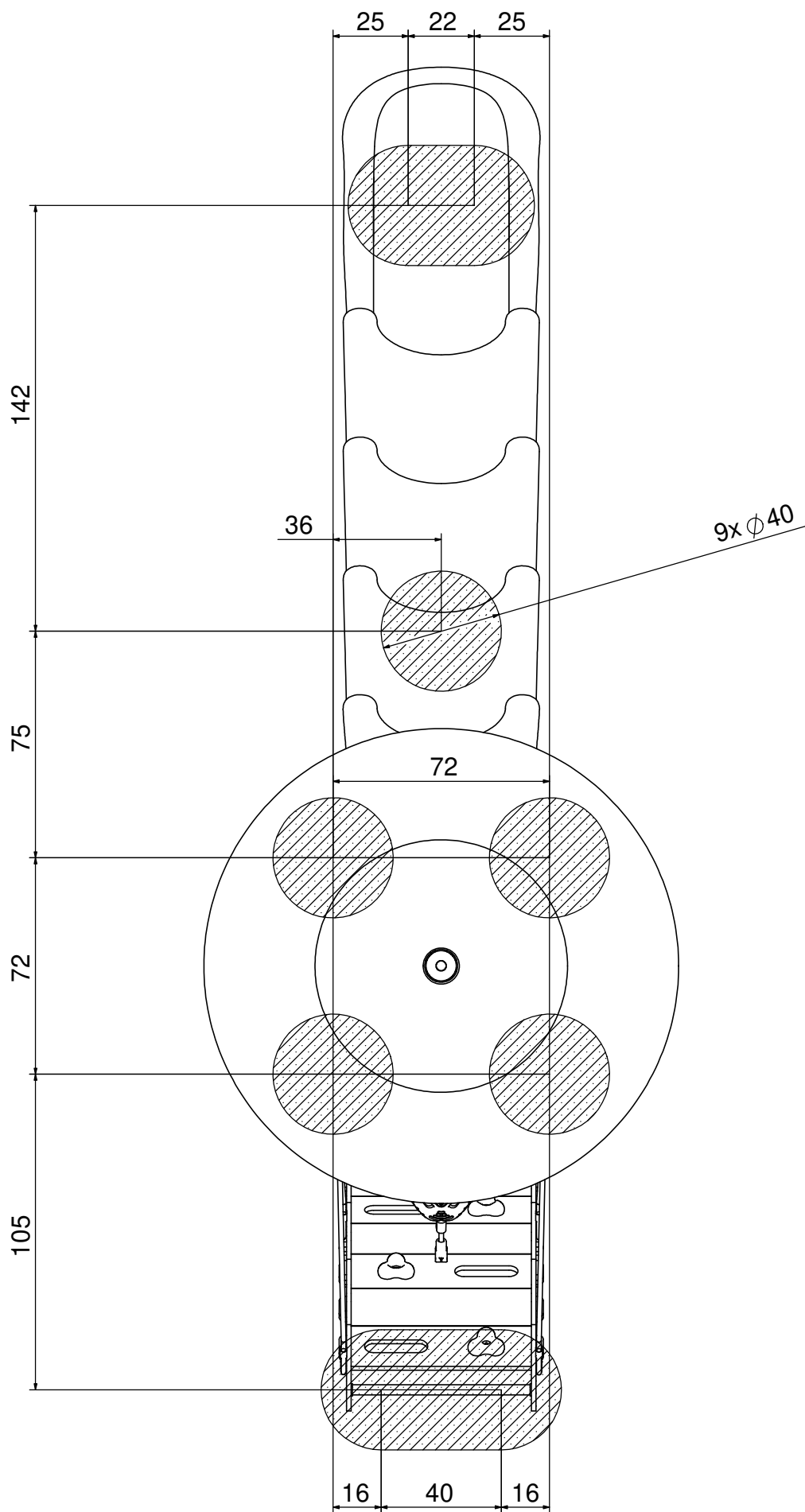

# 8602N

B25 0,25m<sup>3</sup>

min. 48H

