

8603N

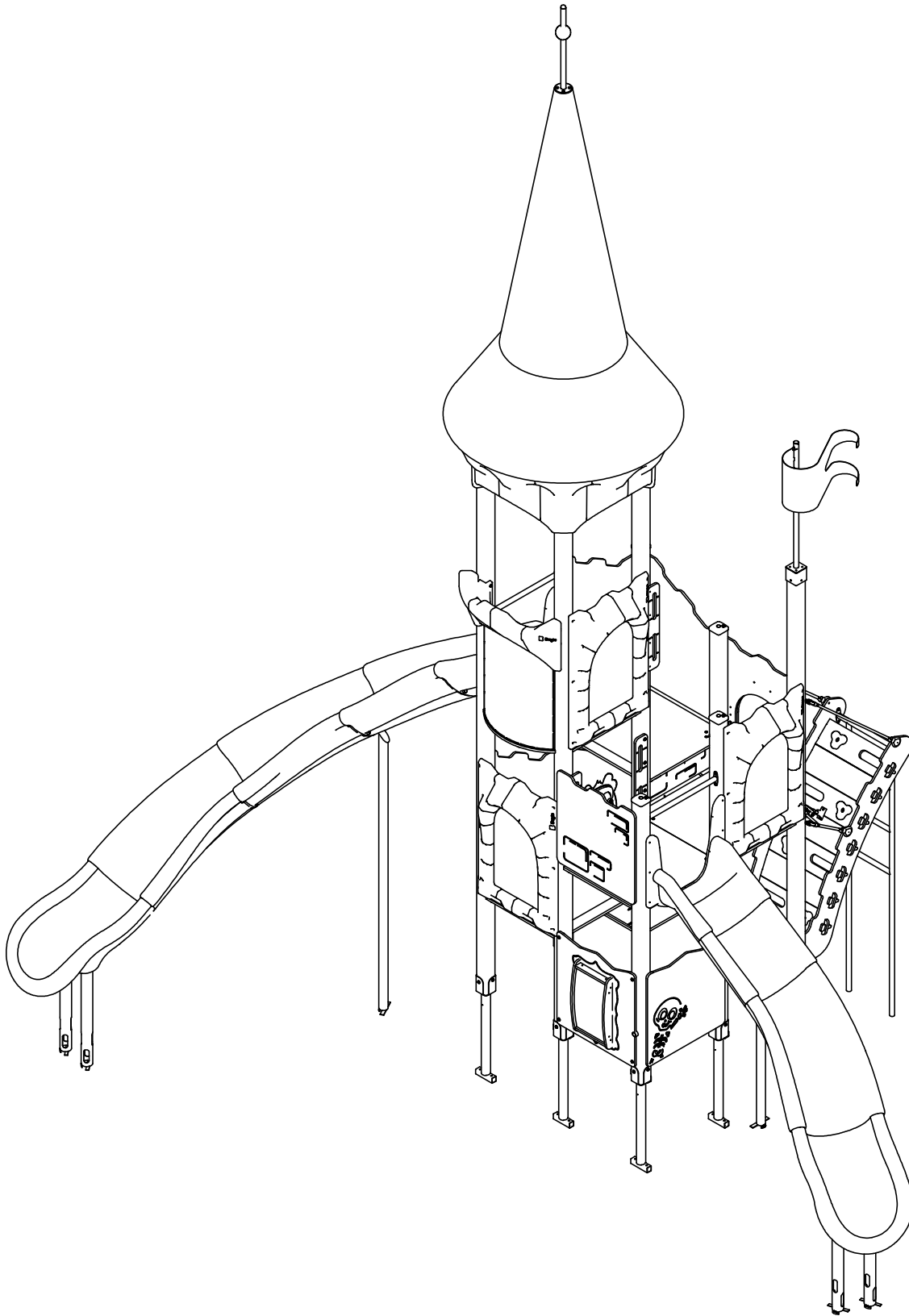

8603N

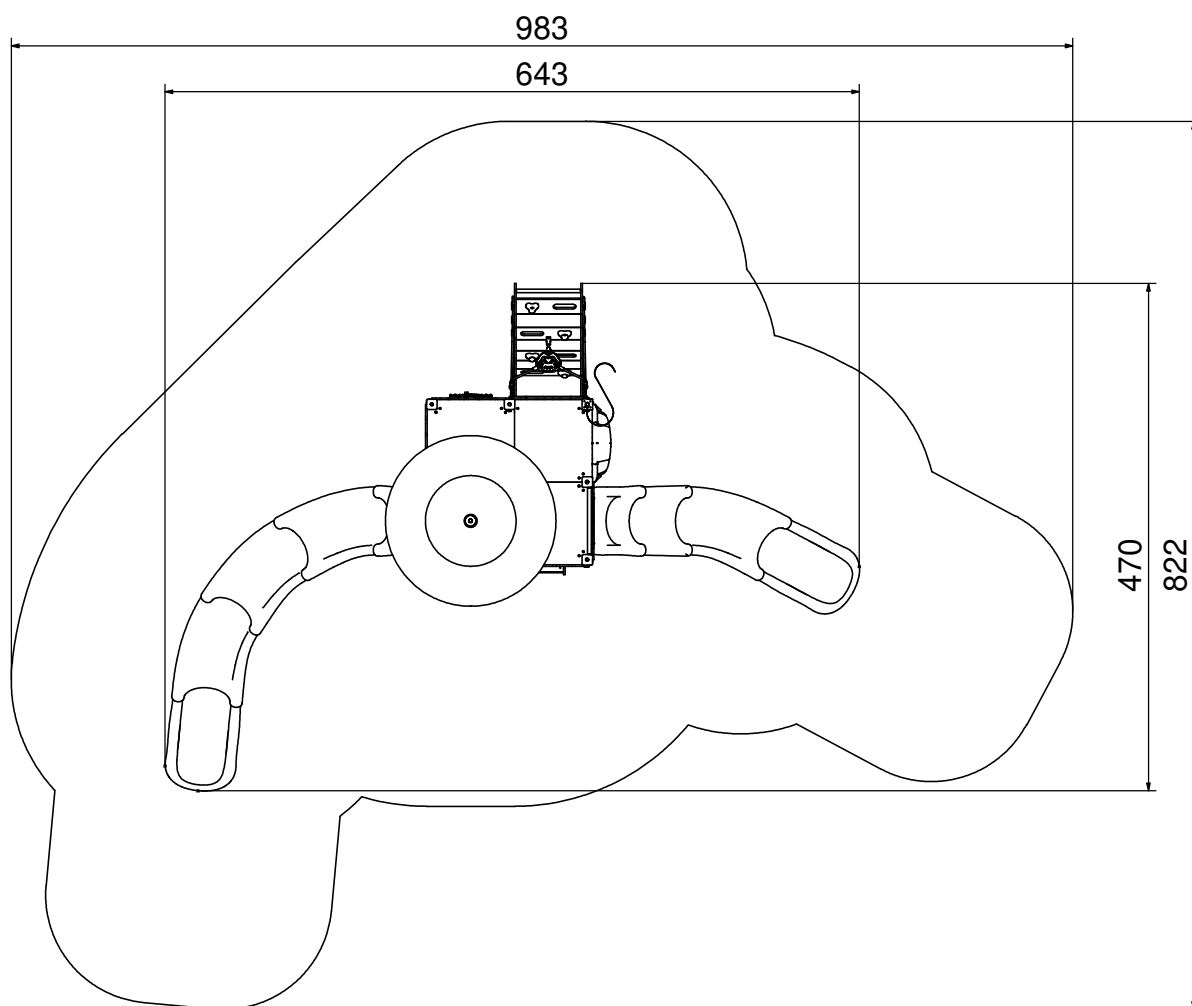
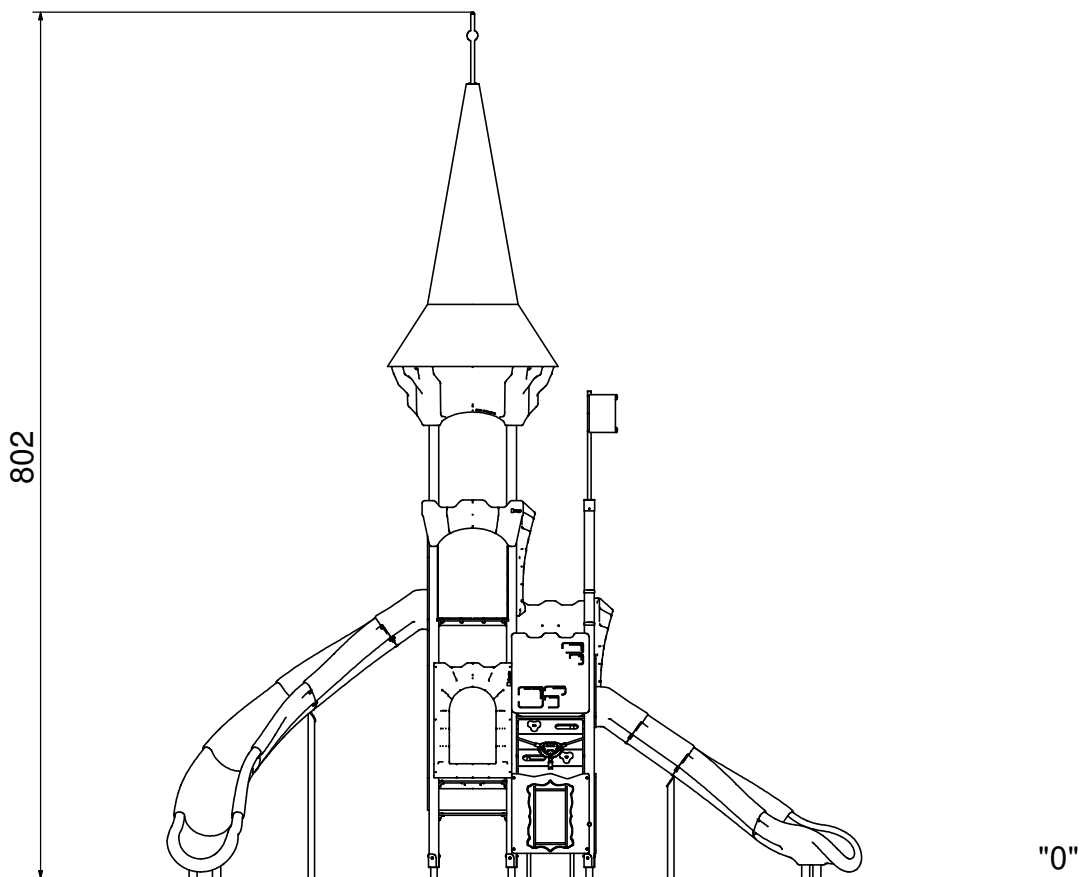

8603N

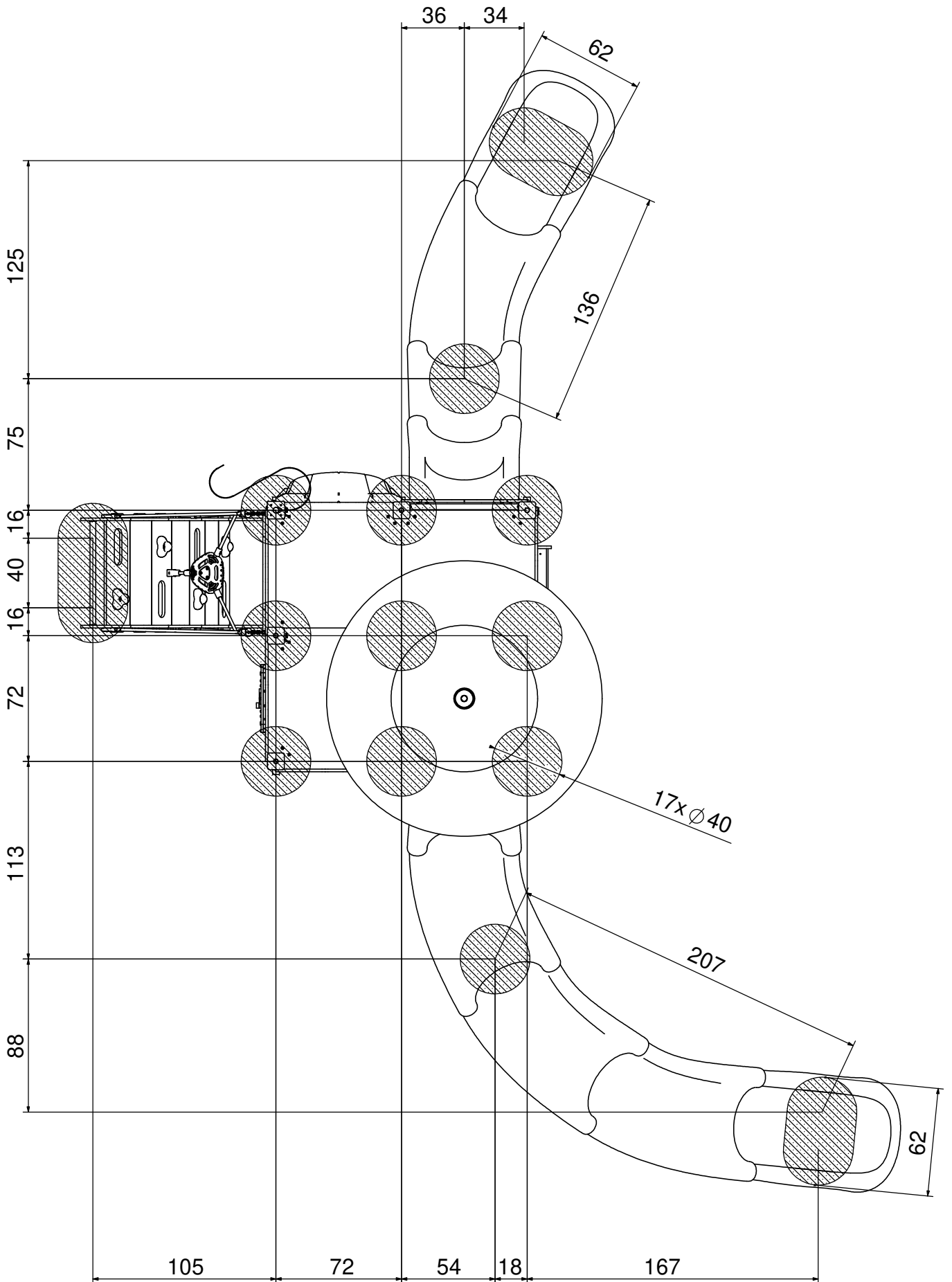

8603N

B25 0,45m³

min. 48H

