

8605N

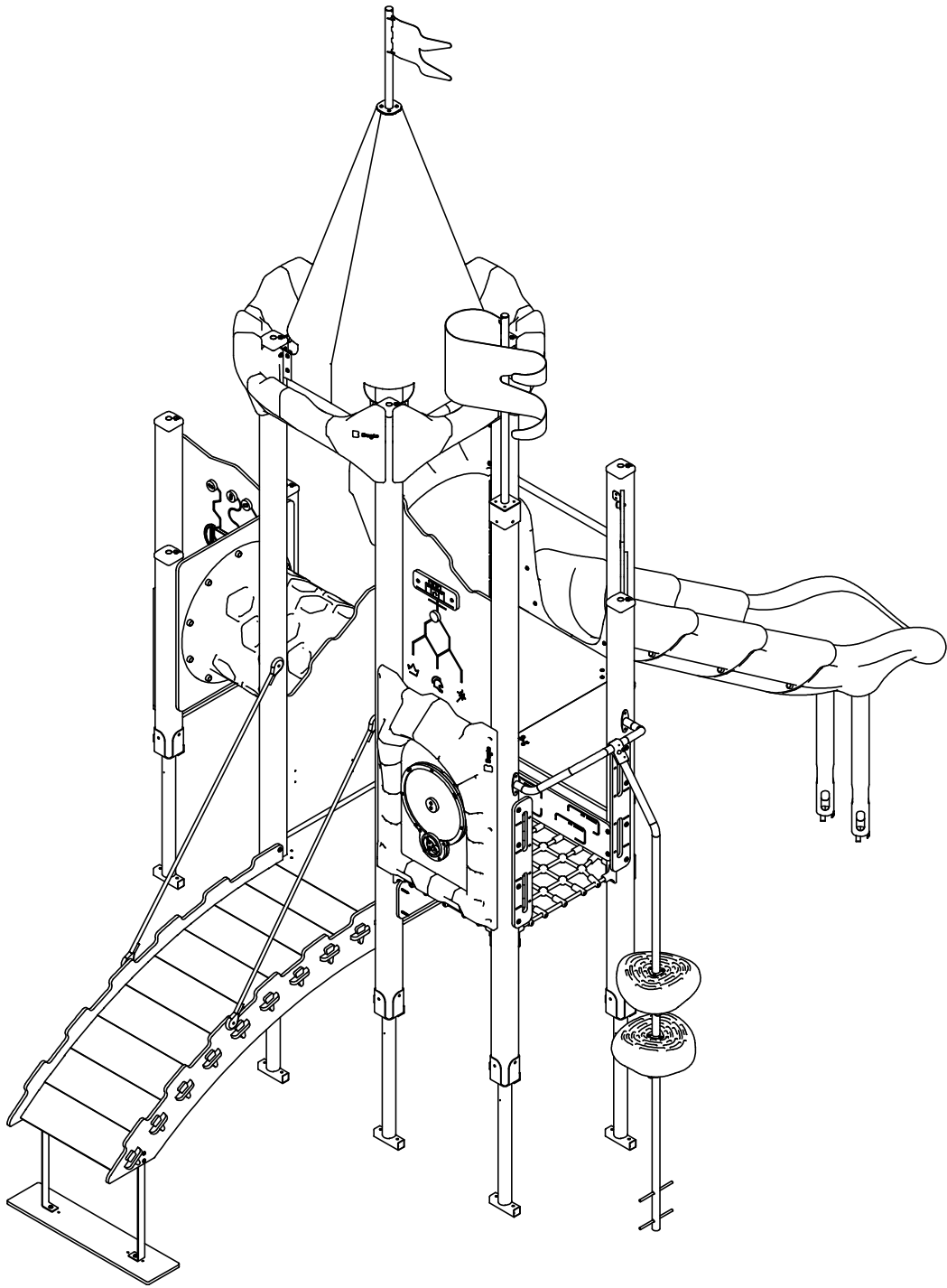

8605N

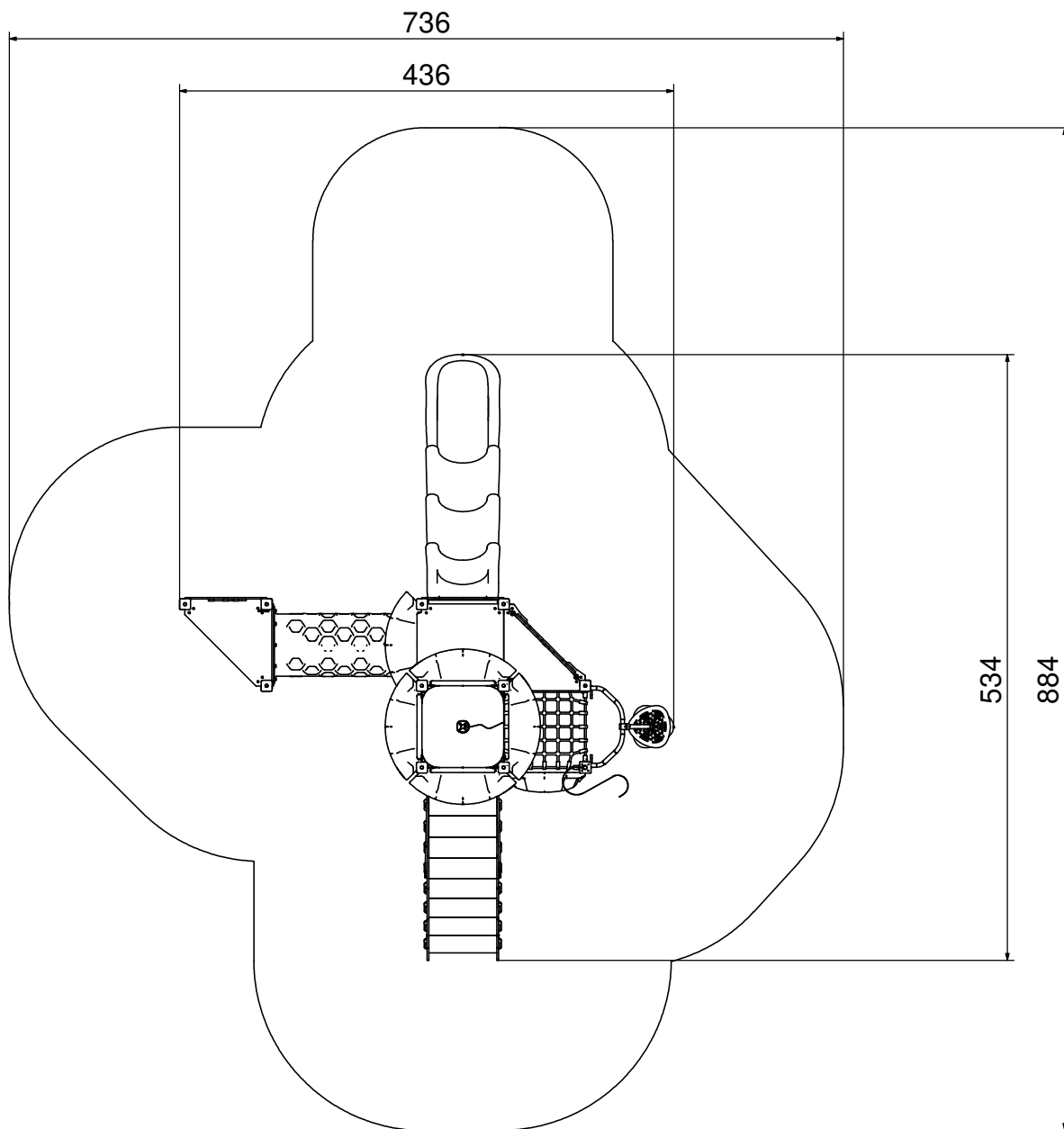
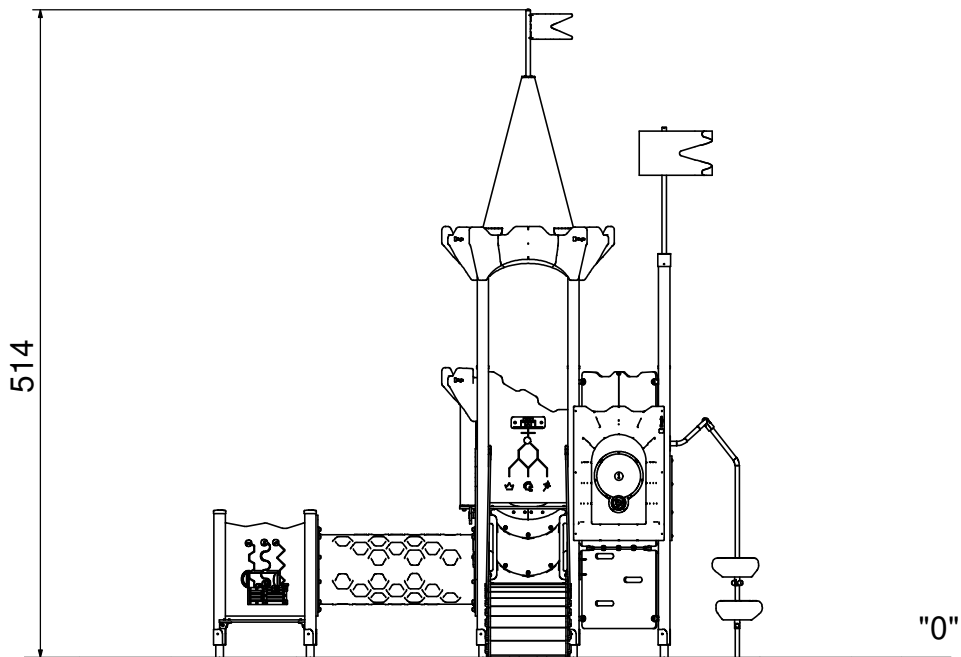

8605N

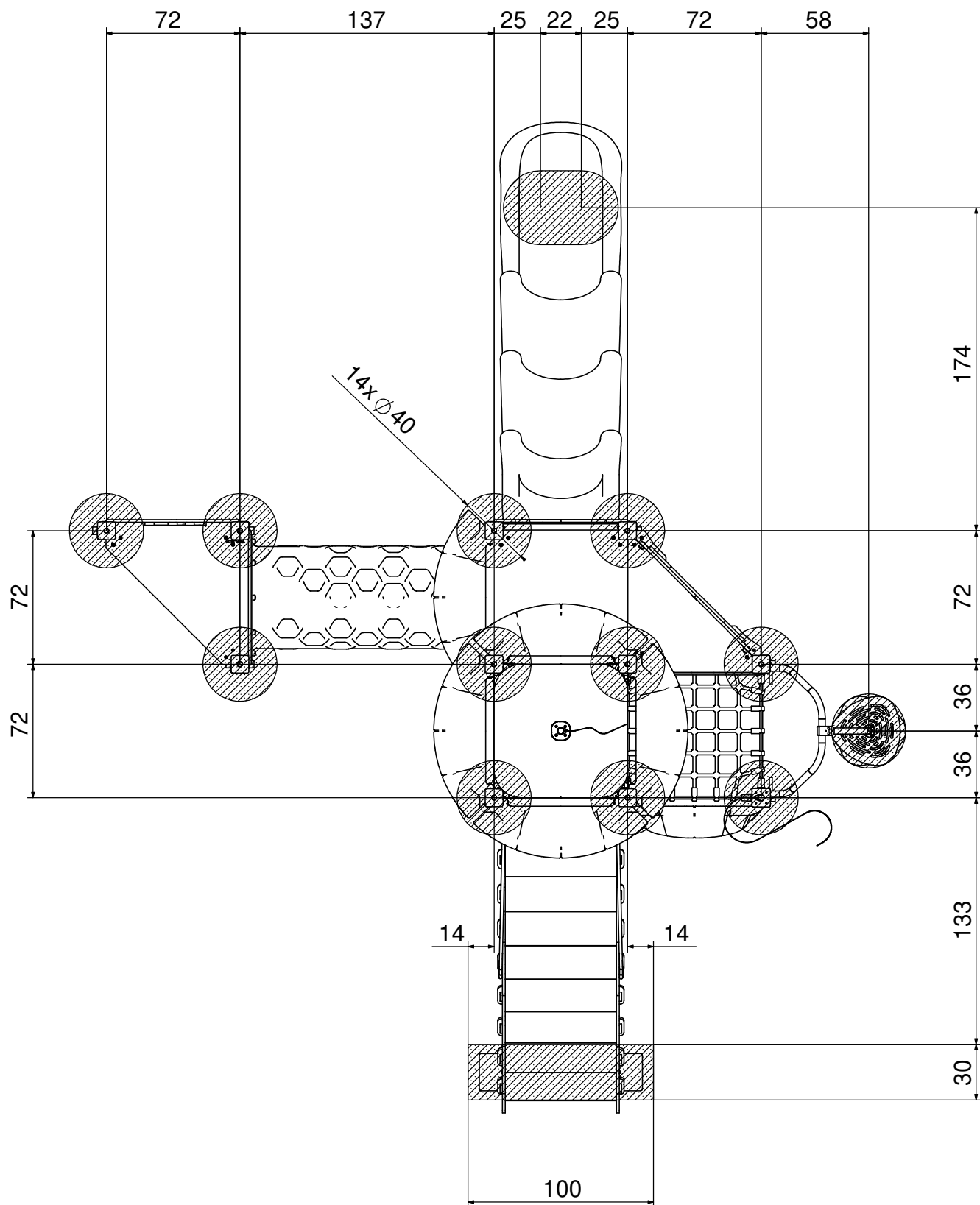

8605N

B25 0,45m³

min. 48H

