

8607N

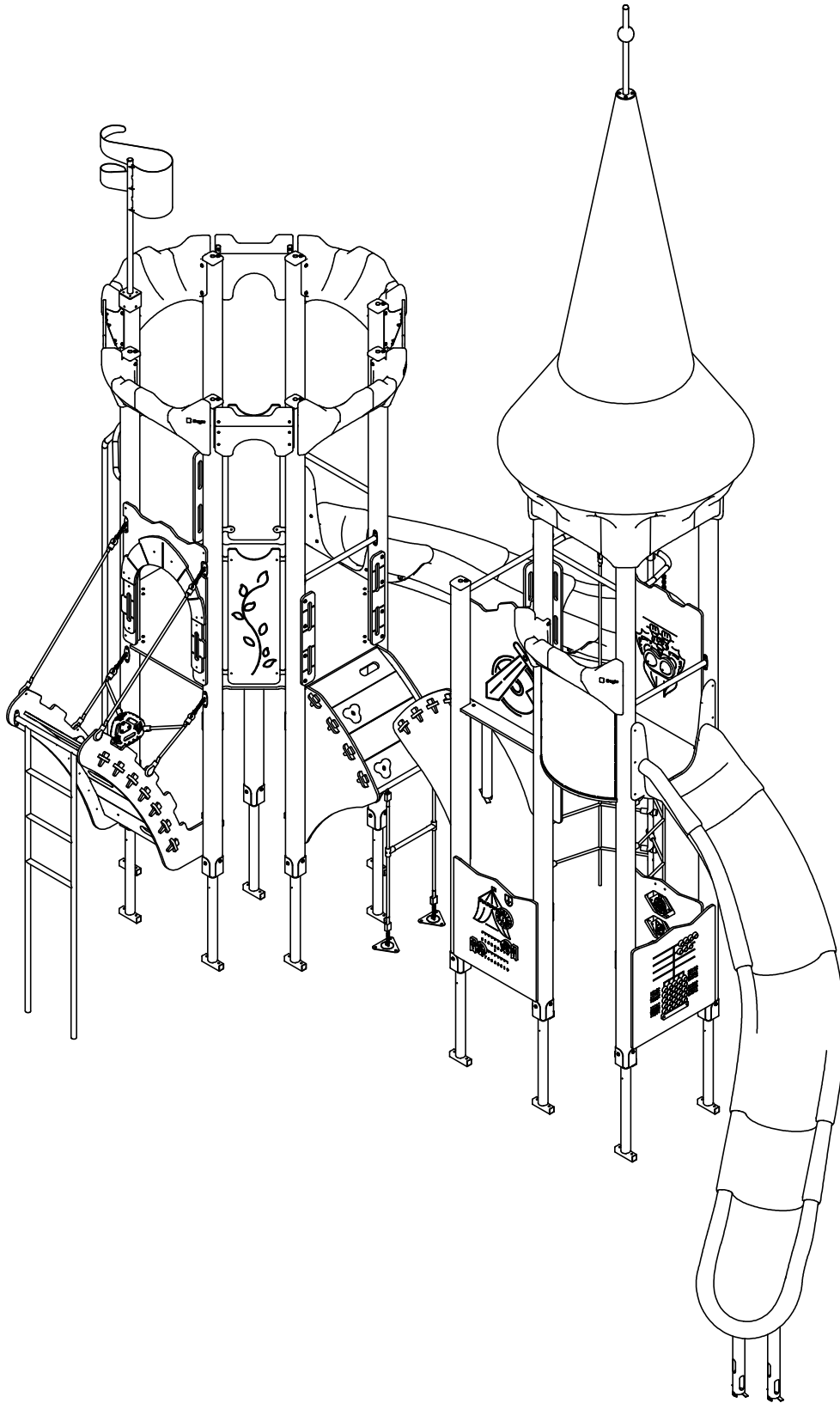

8607N

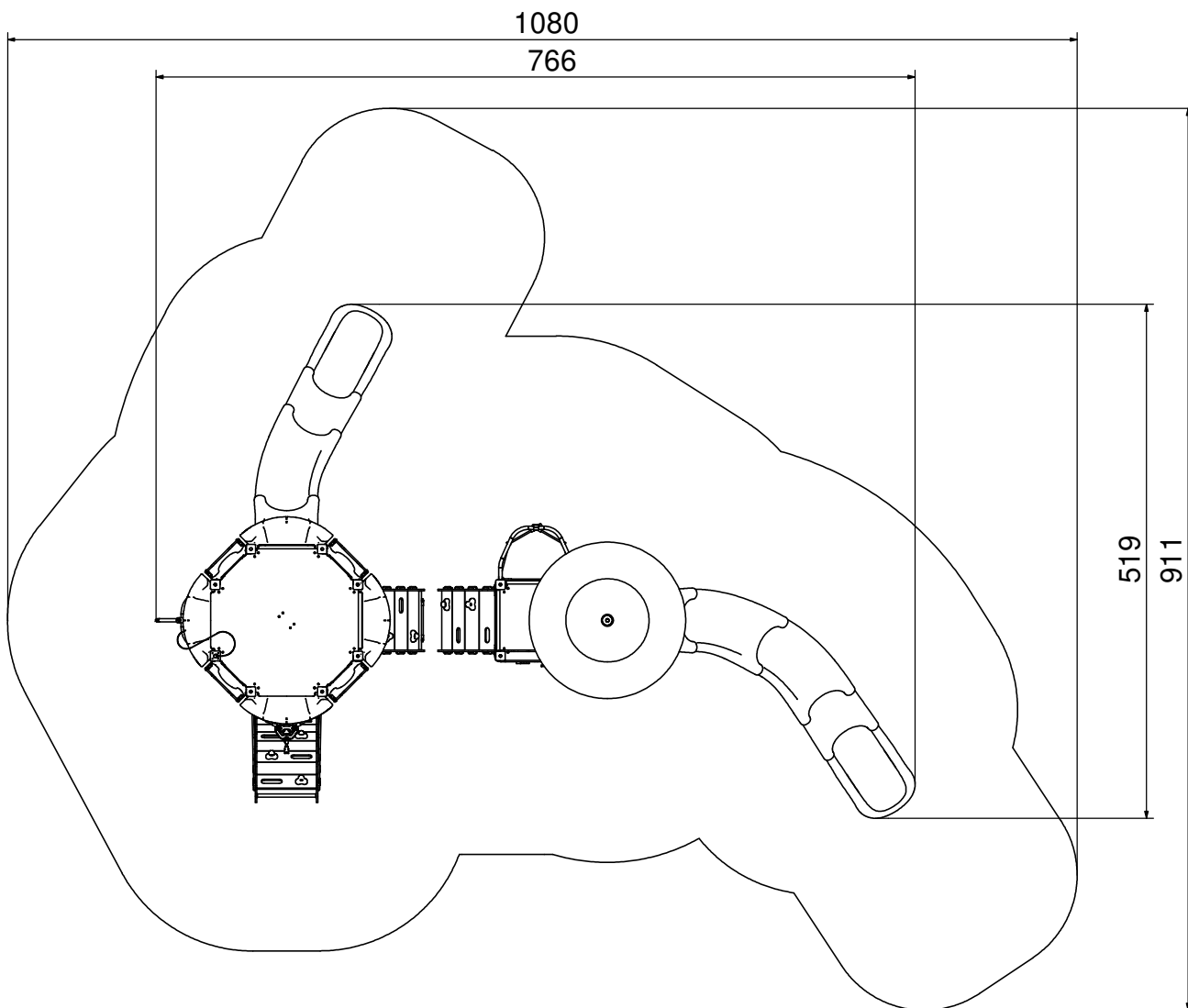
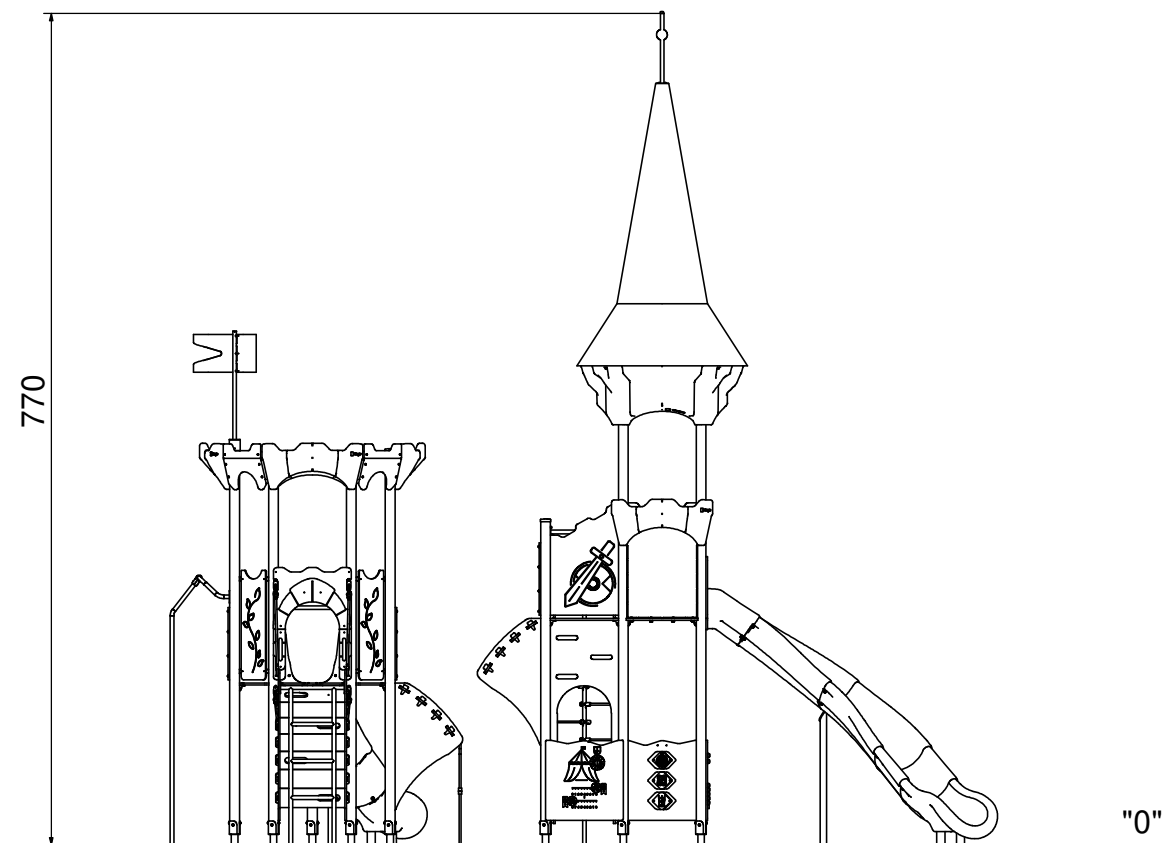

8607N

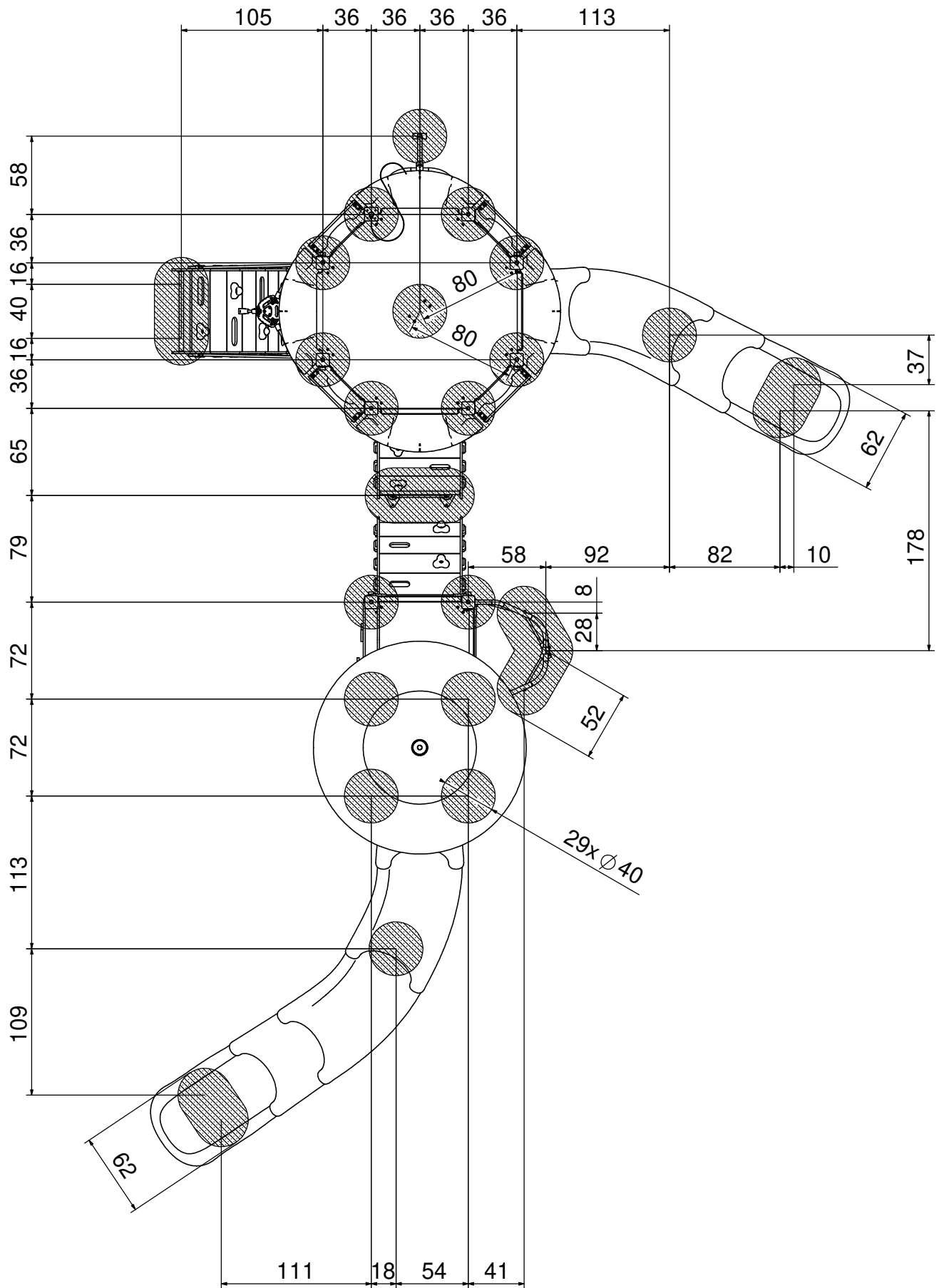

8607N

B25 0,75m³

min. 48H

