

8608N

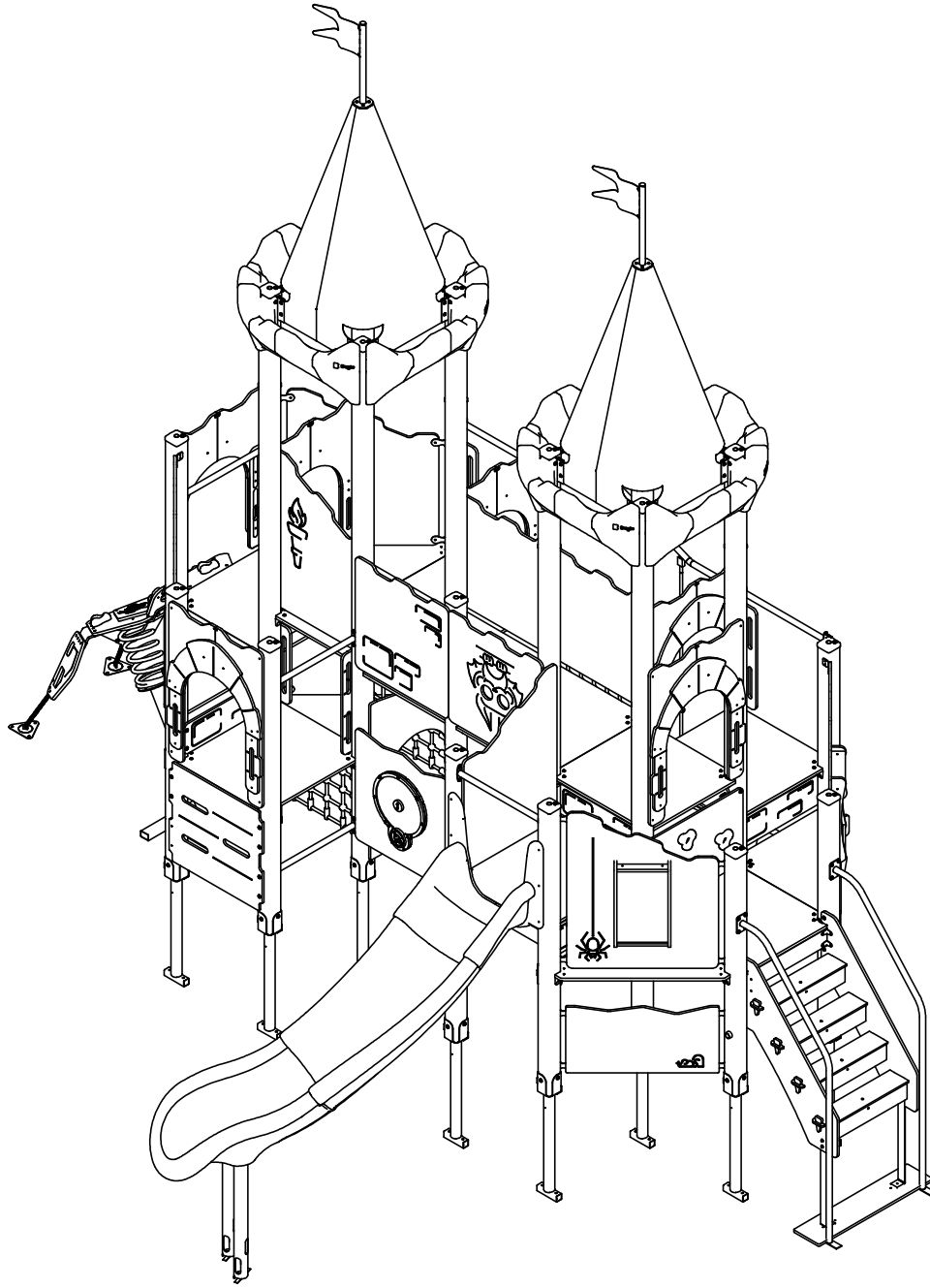

8608N

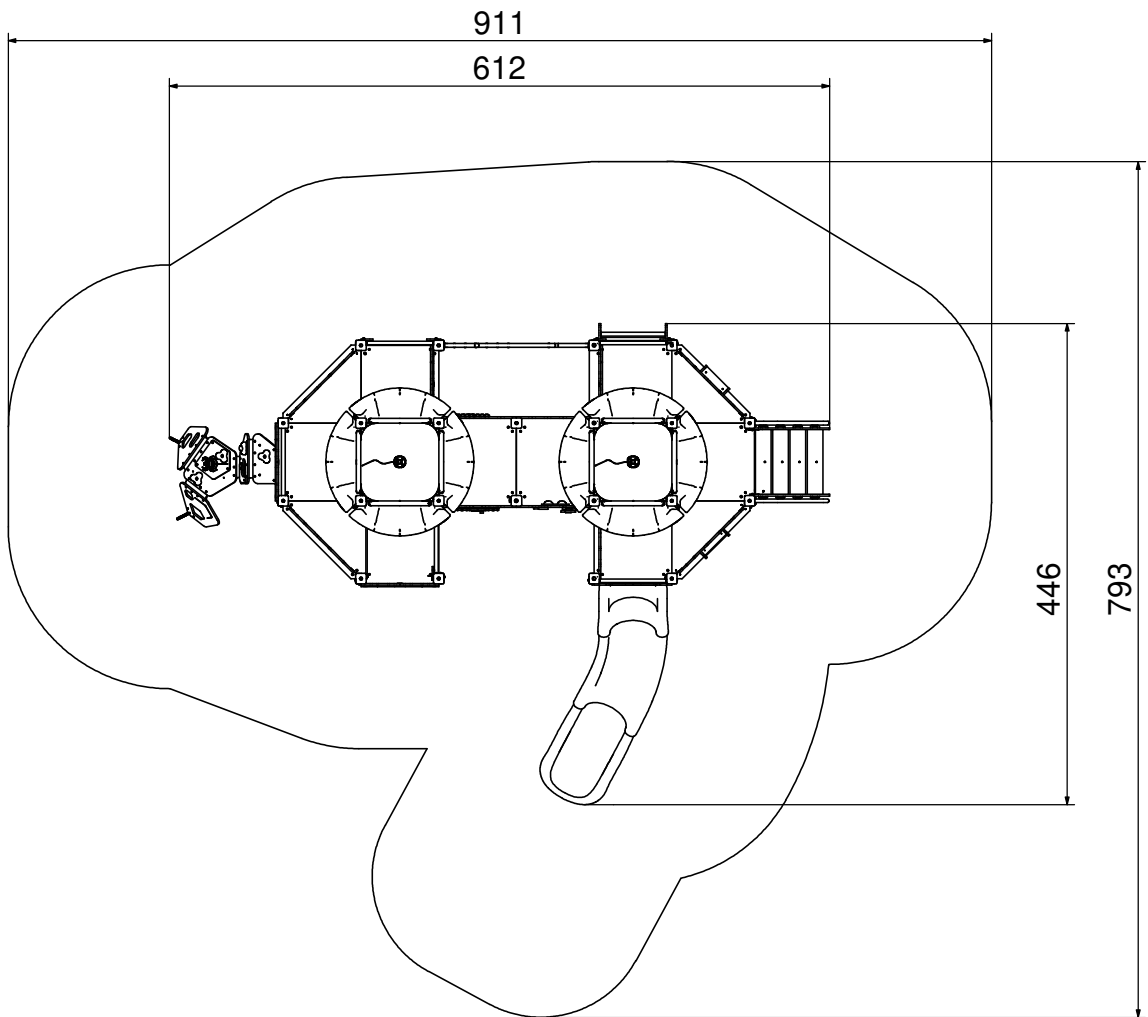
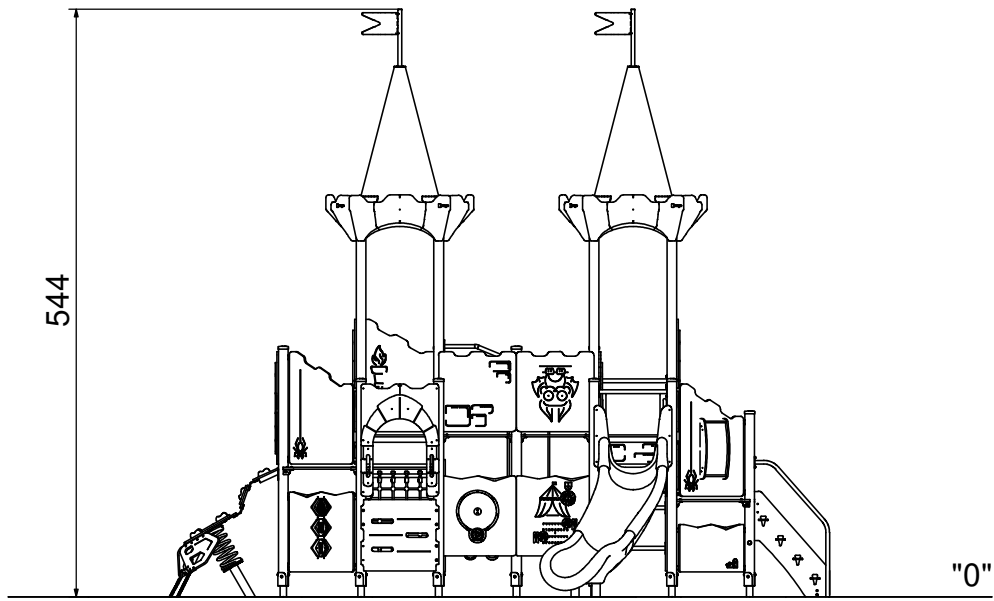

8608N

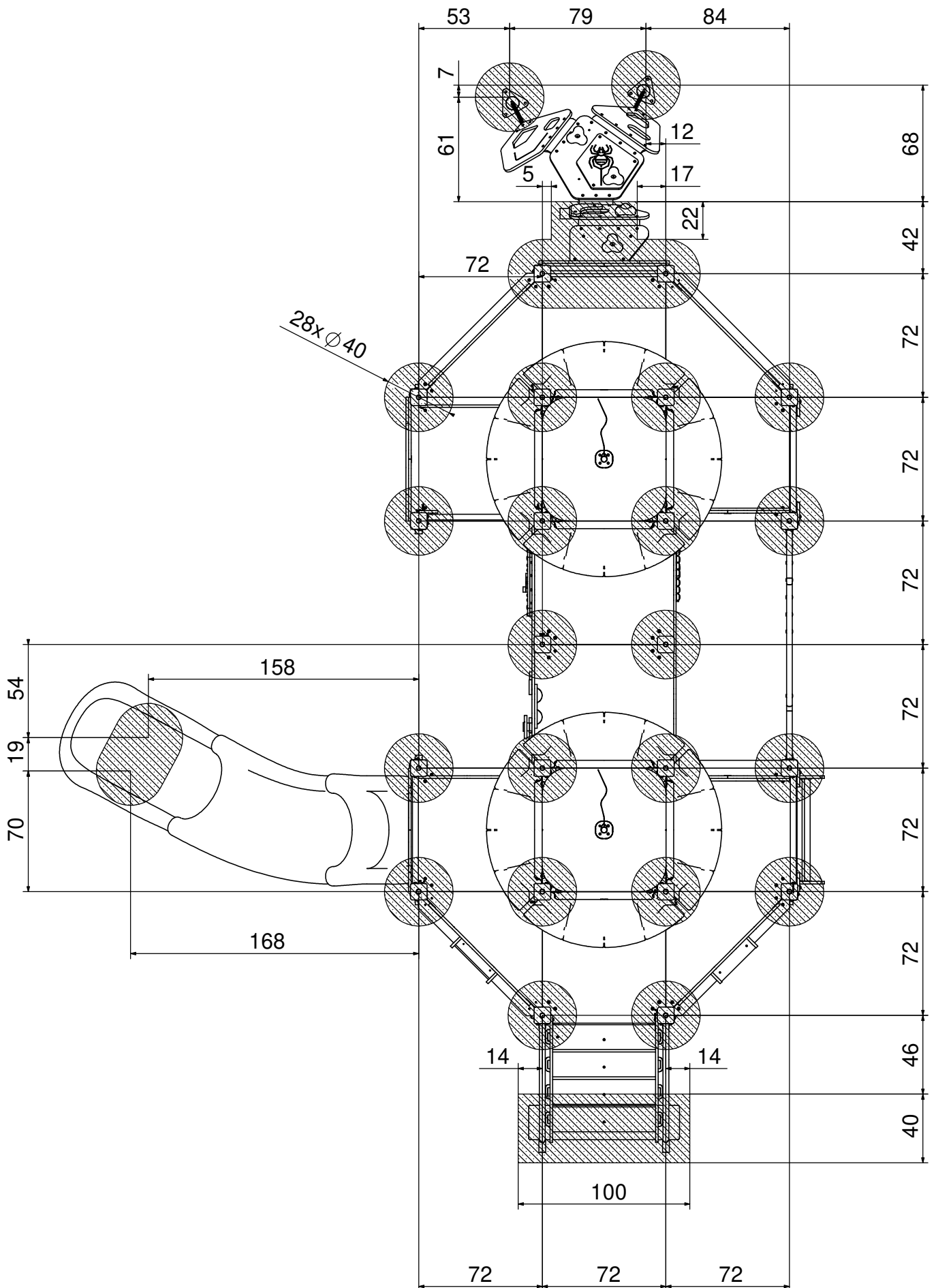

8608N

B25 0,8m³

min. 48H

