

8609N

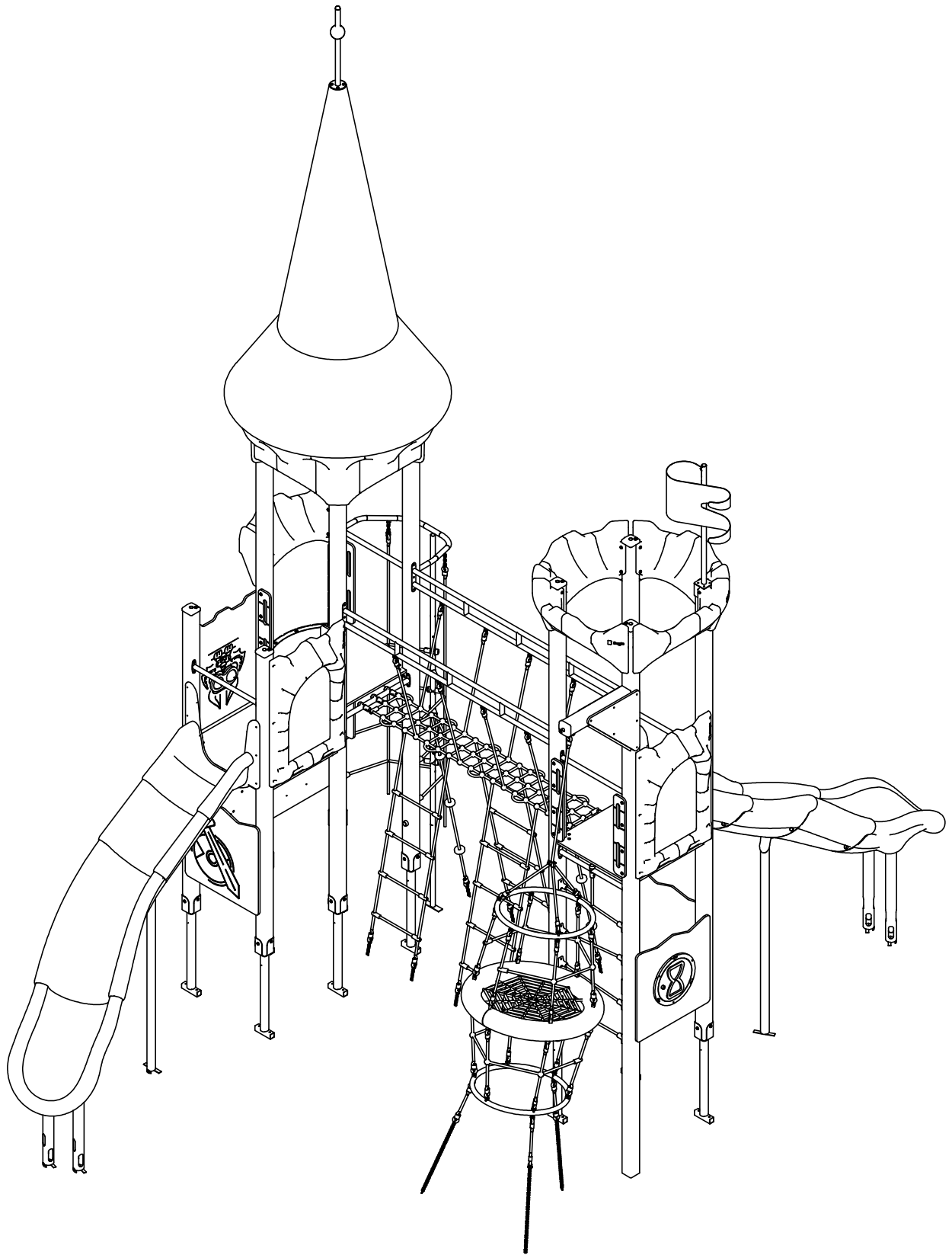

8609N

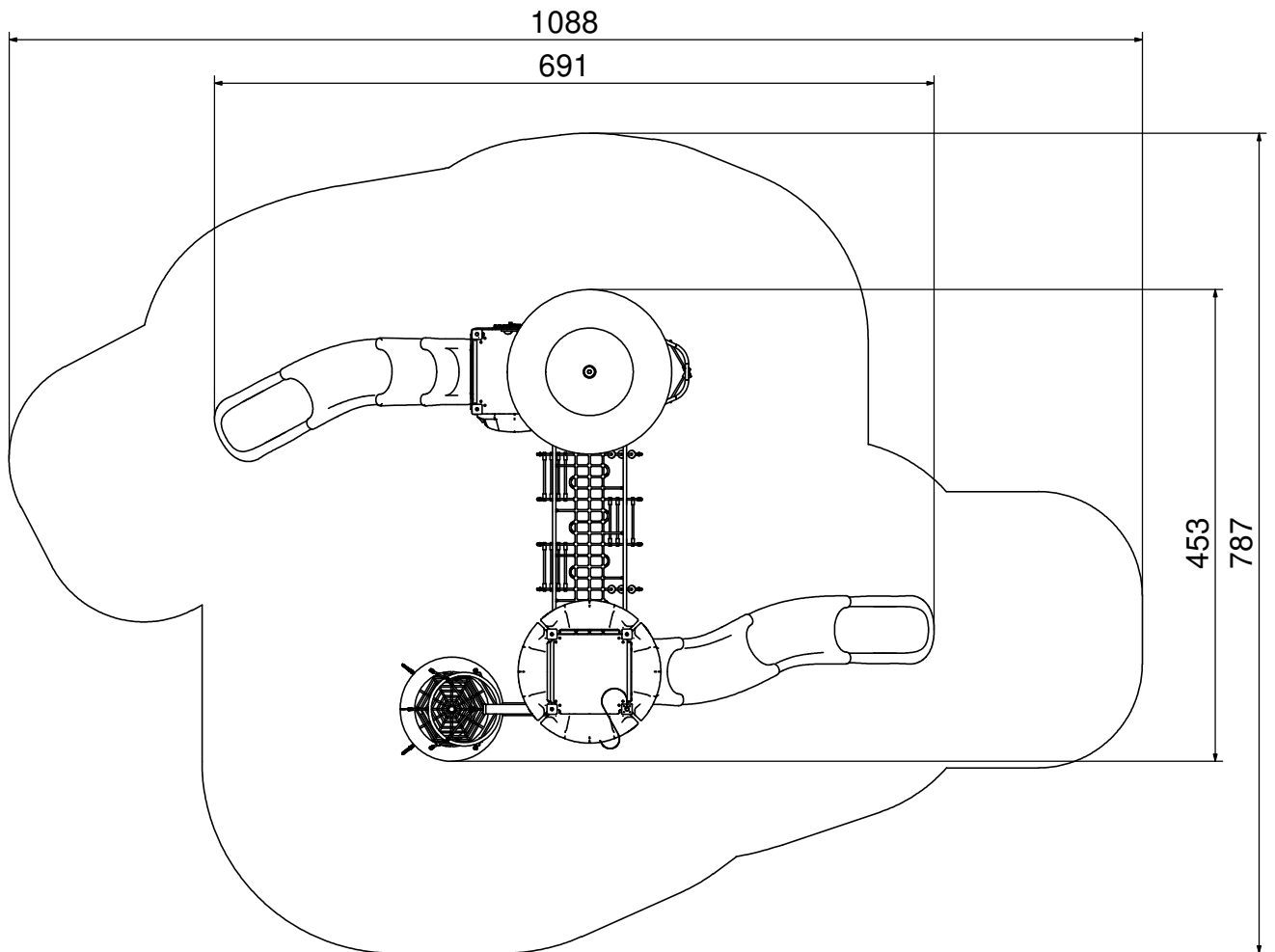
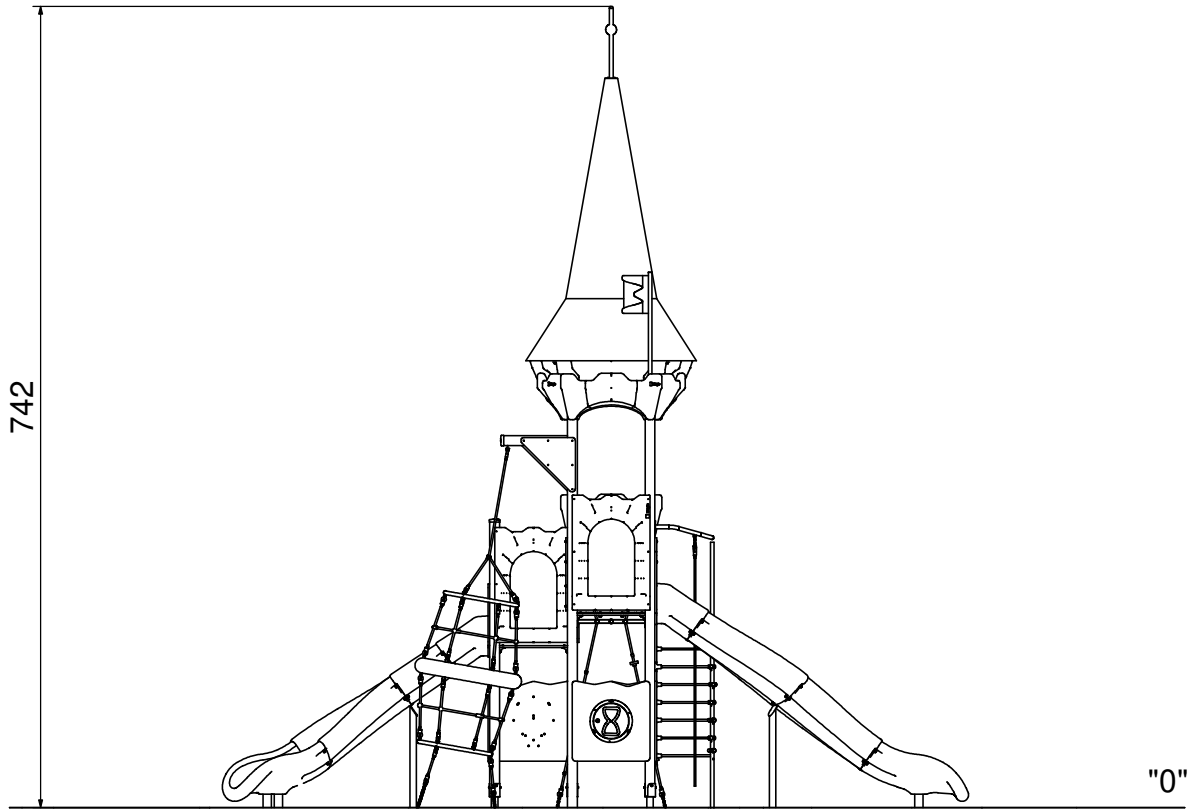

8609N

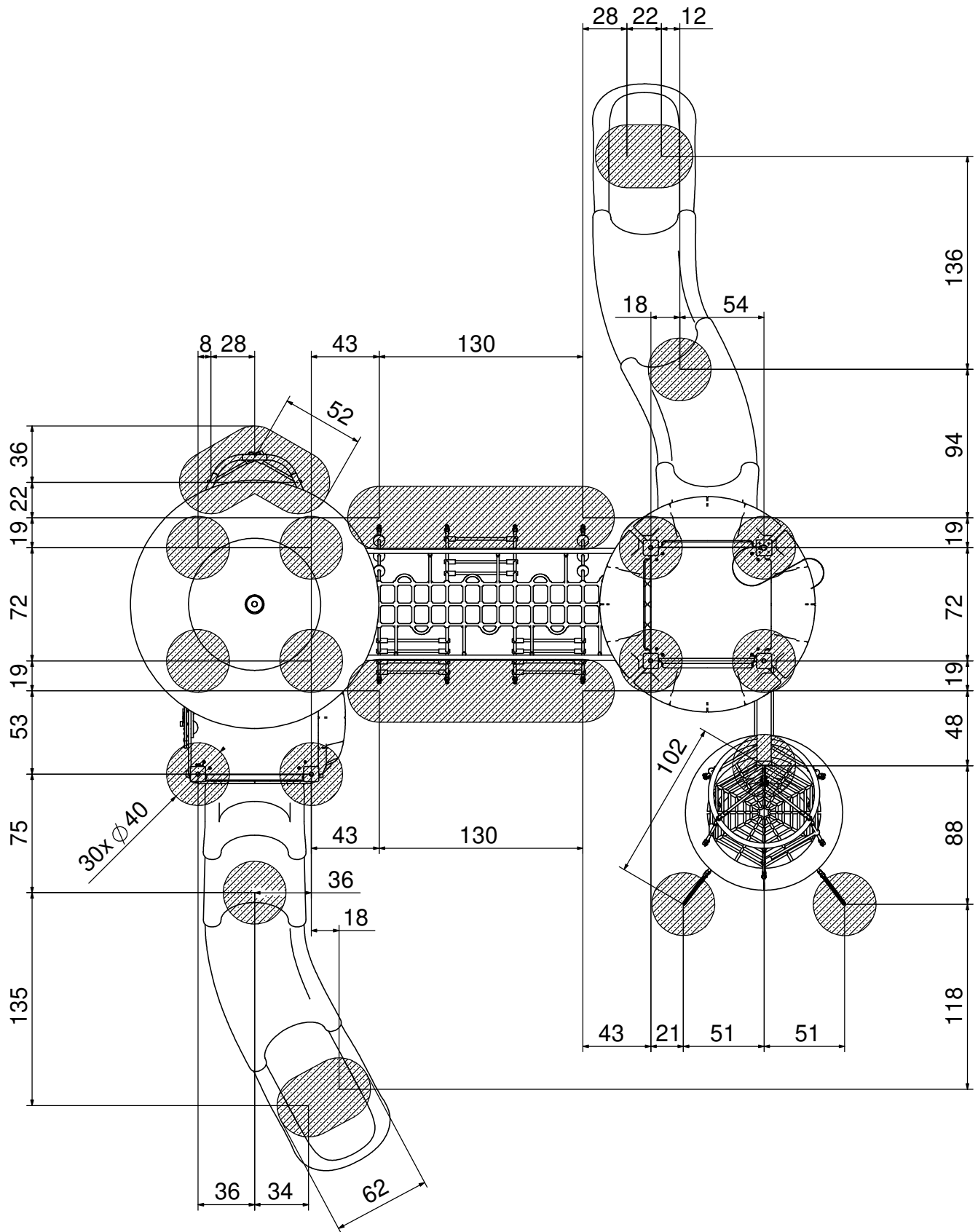

8609N

B25 0,8m³

min. 48H

