

8613N

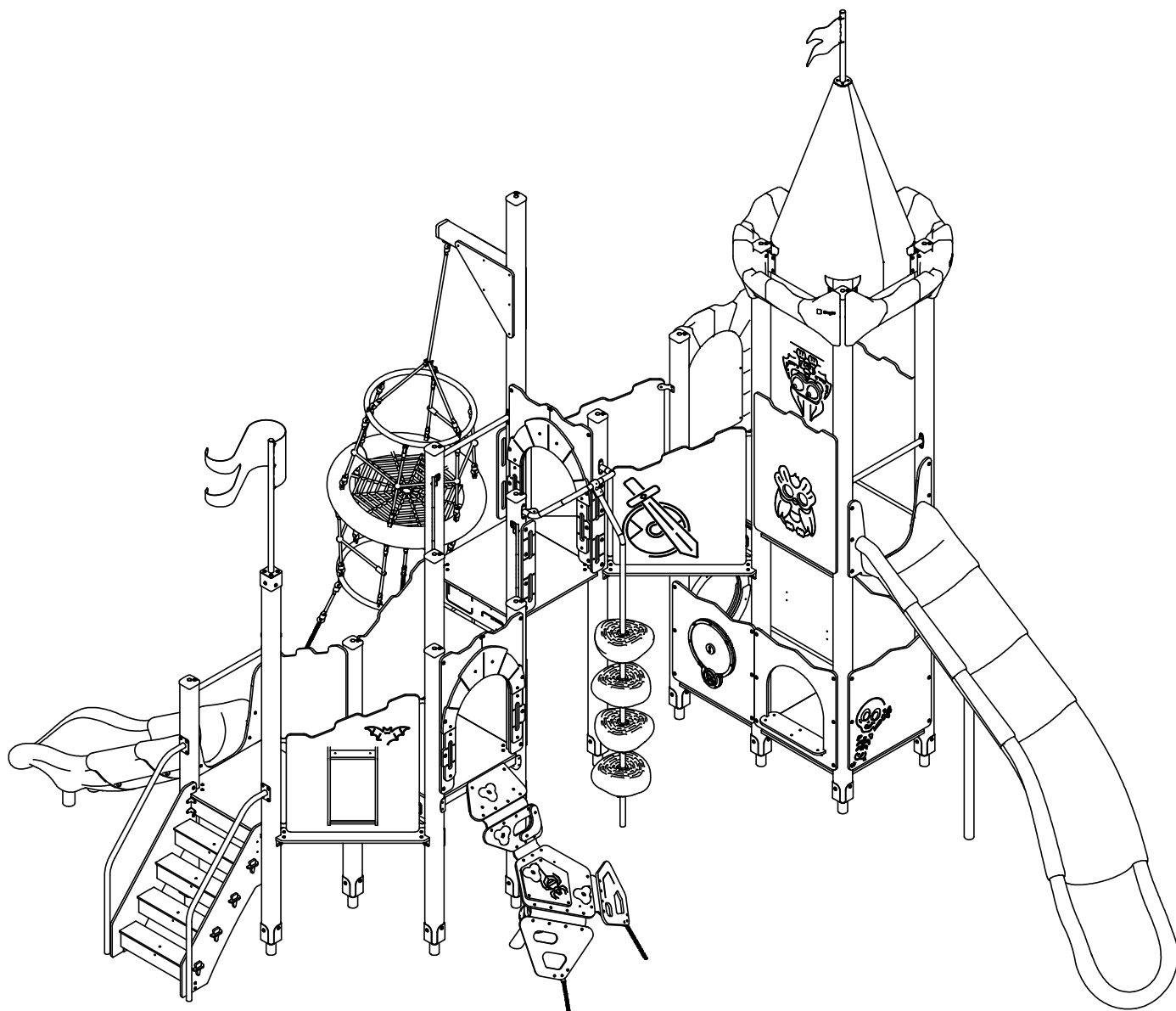

8613N

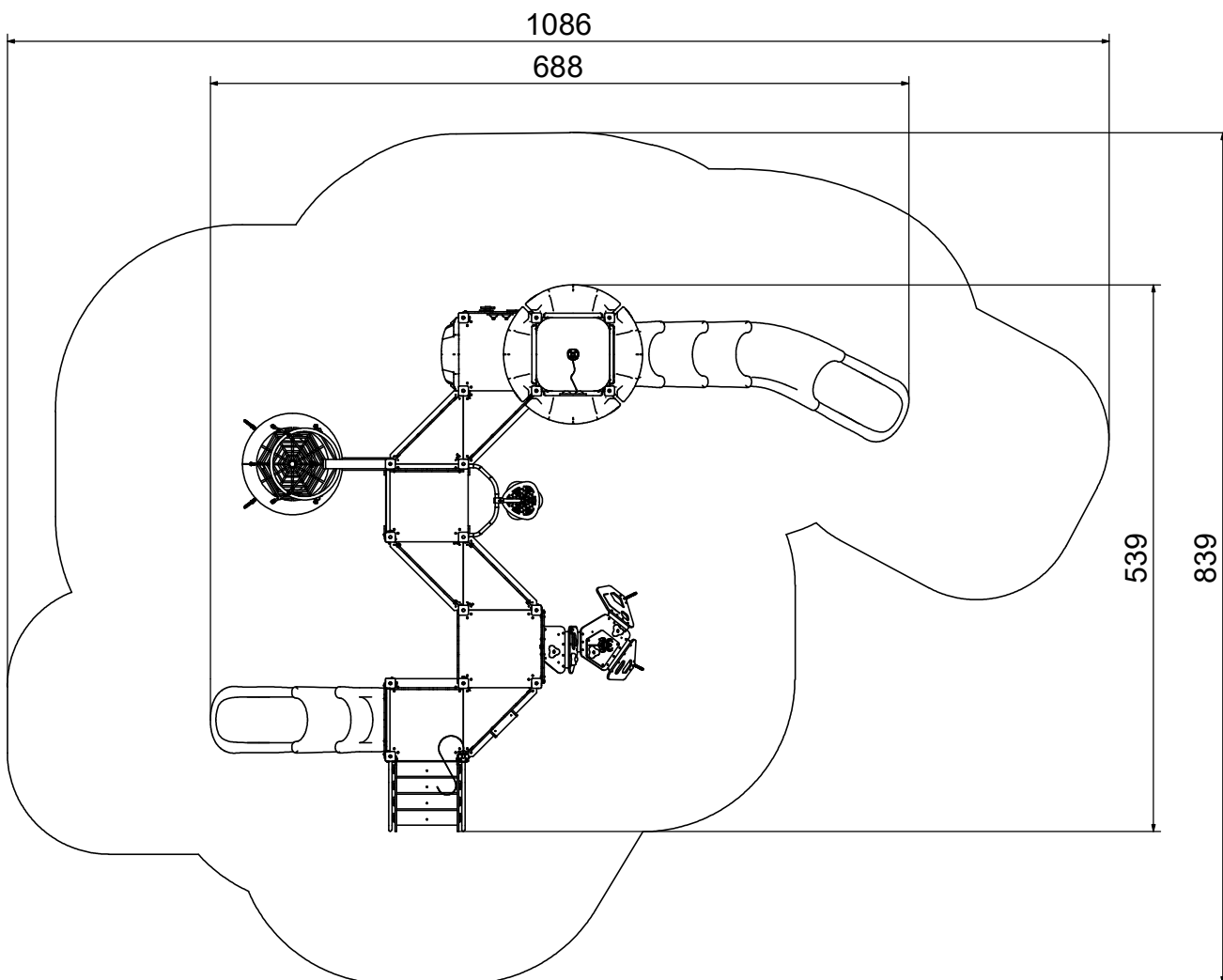
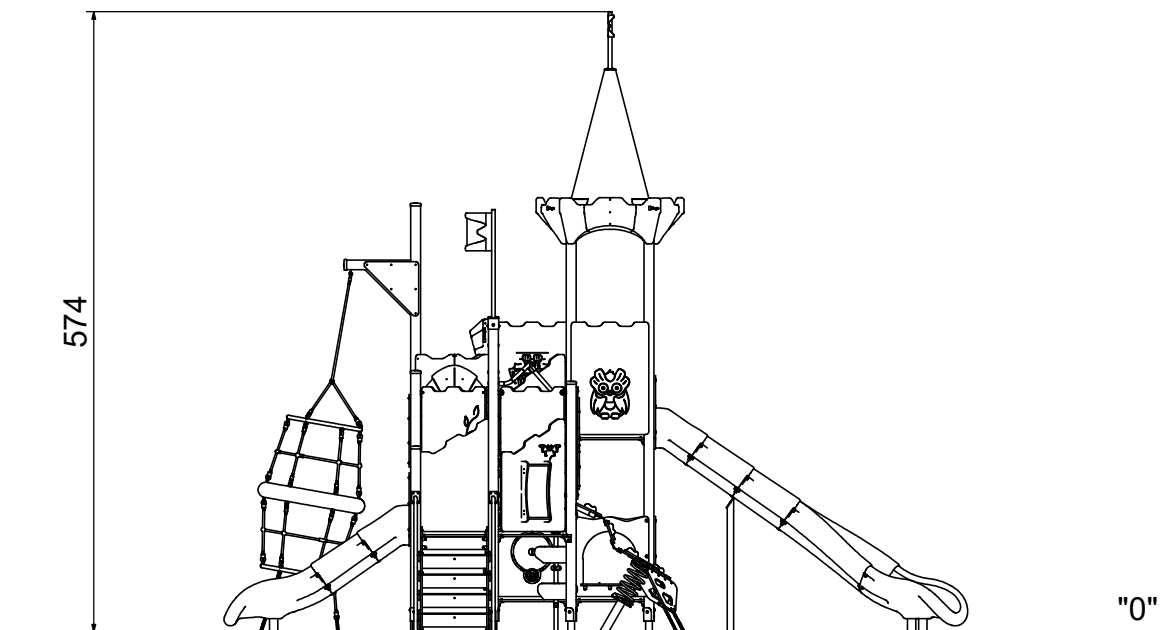

8613N

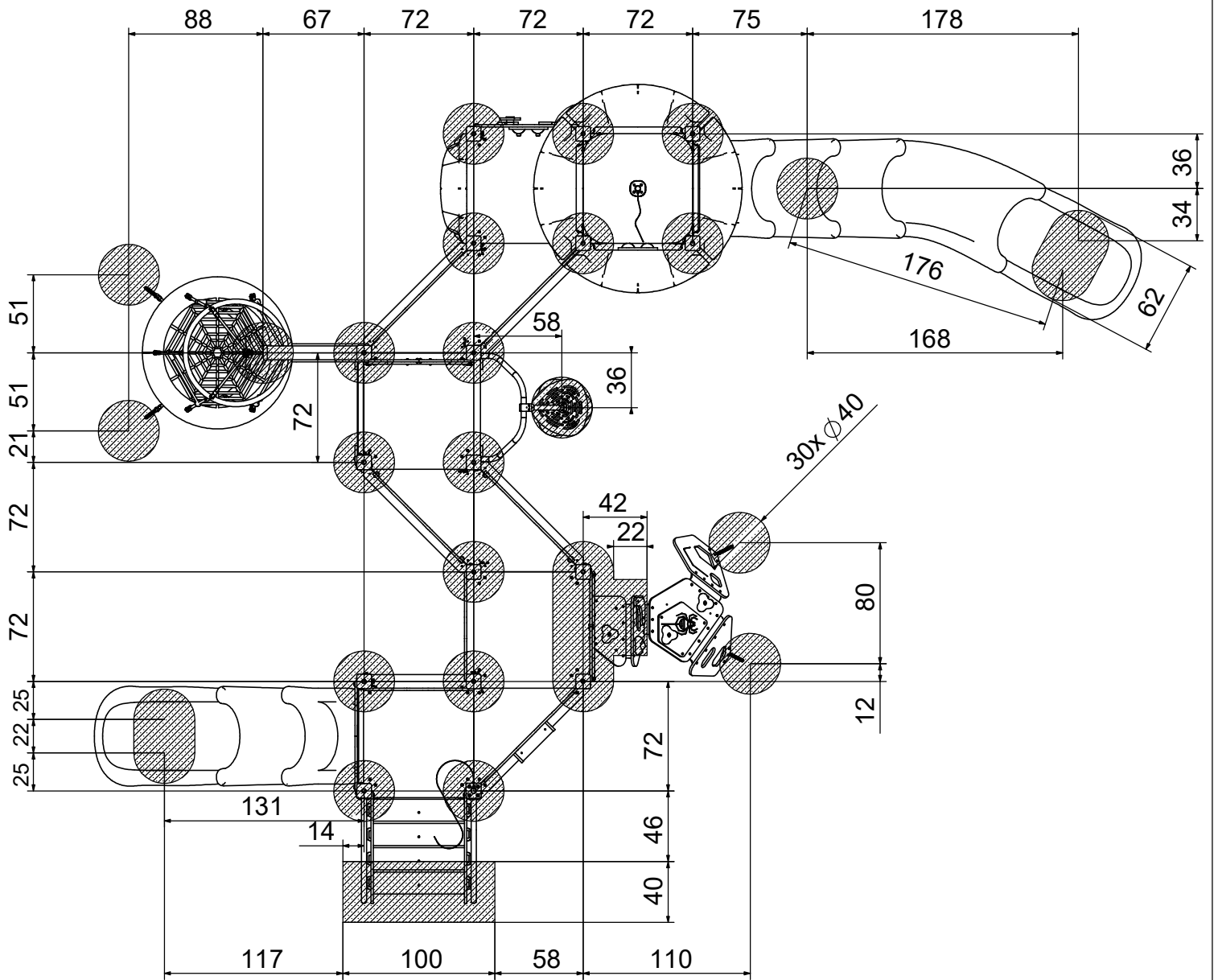

8613N

B25 0,85m³

min. 48H

