

9501

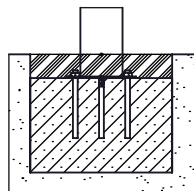

9501N

9501N

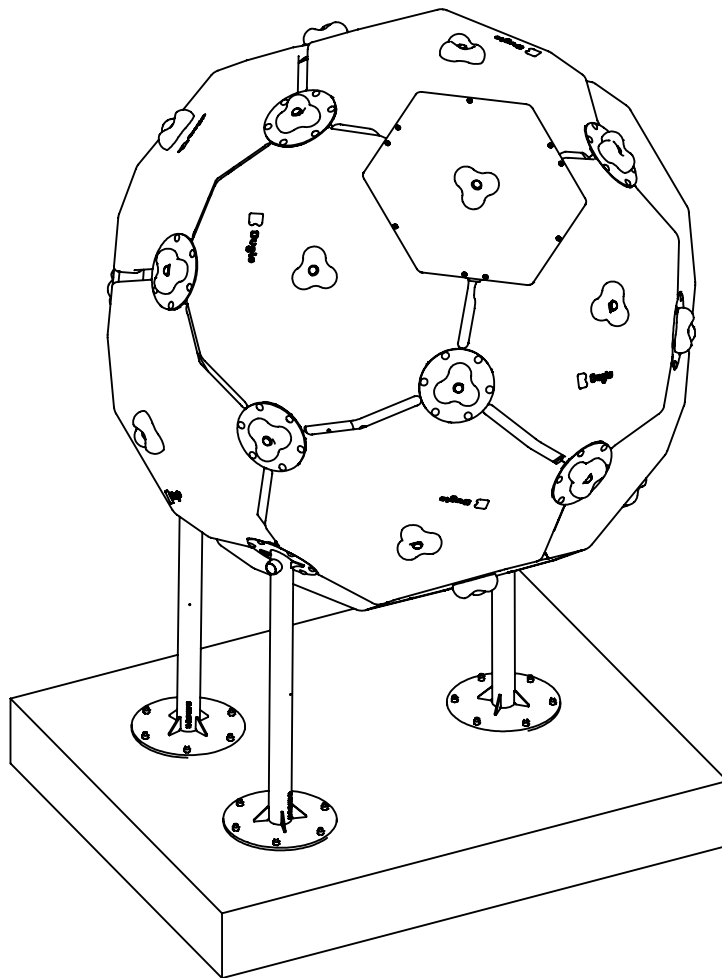
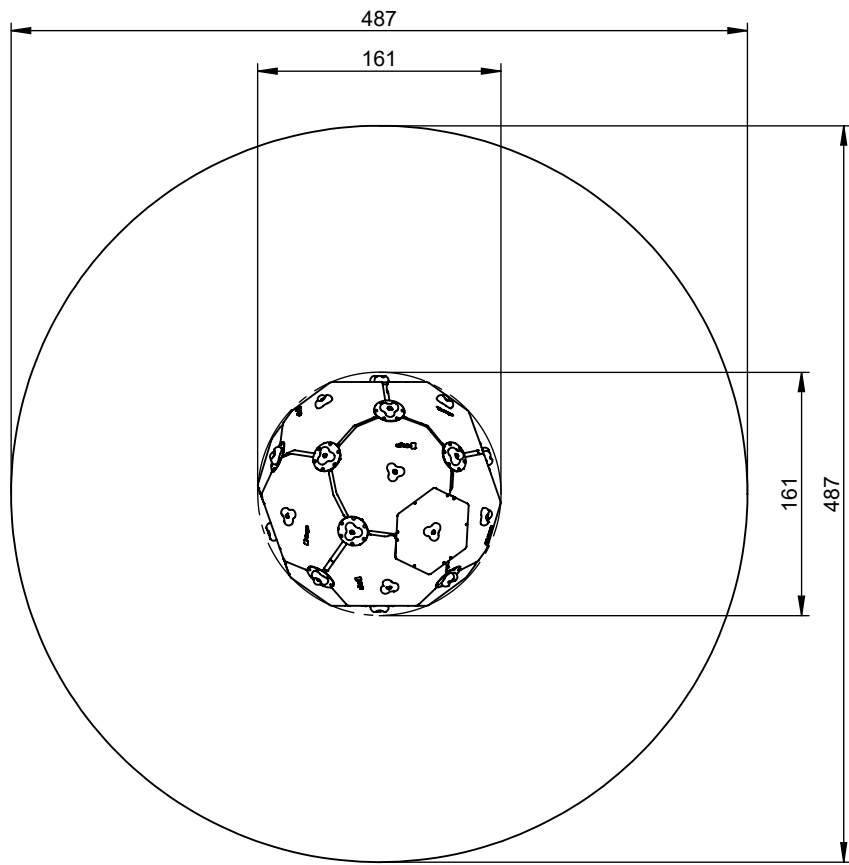
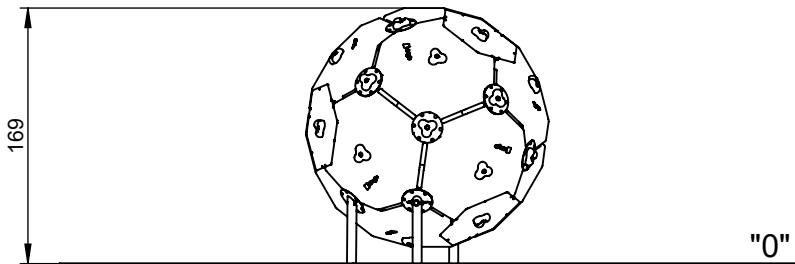

9501N

3

B25 0,4m

min. 48H

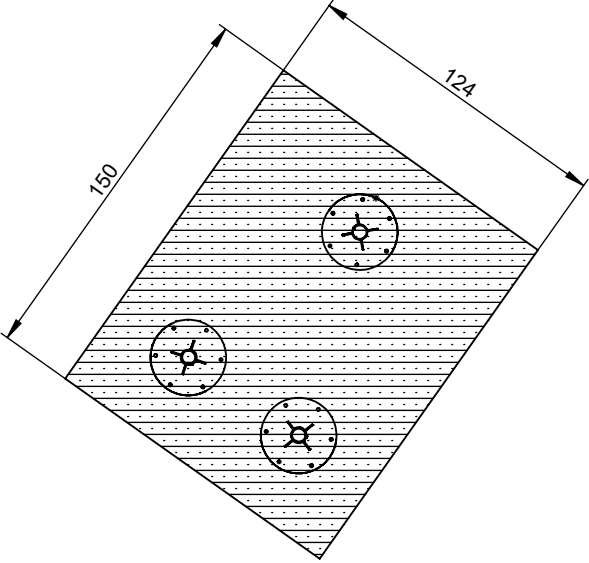
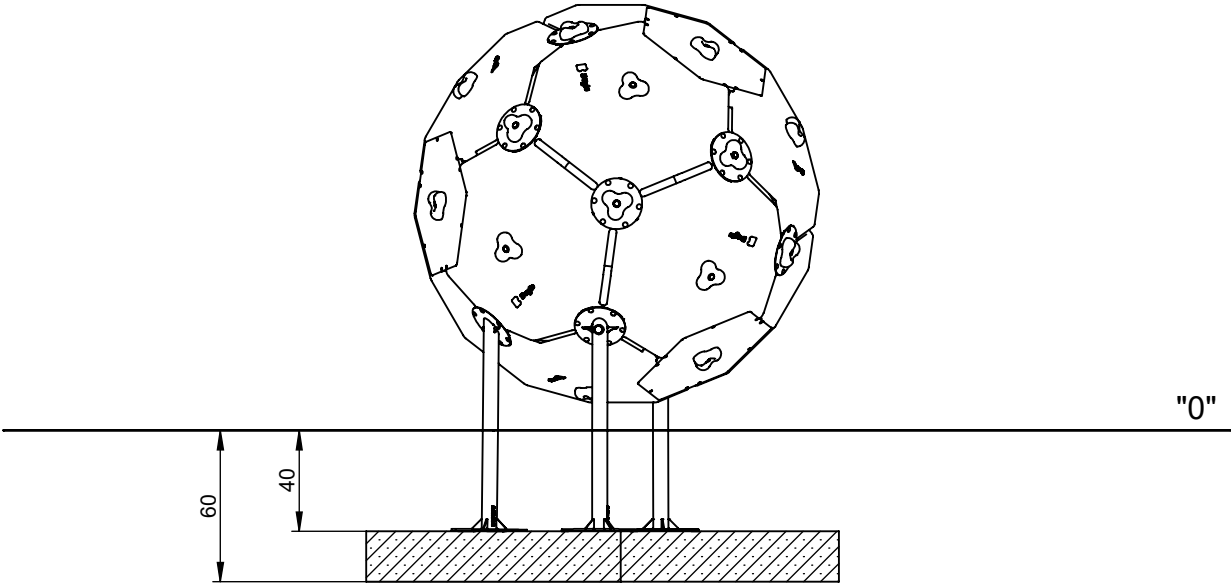
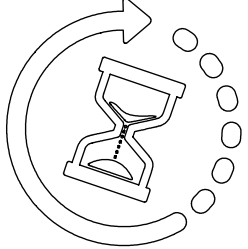
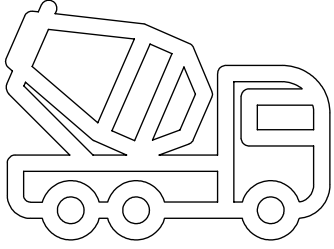
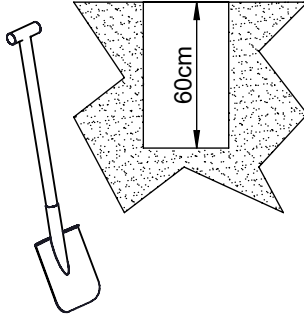

9501N



"0"

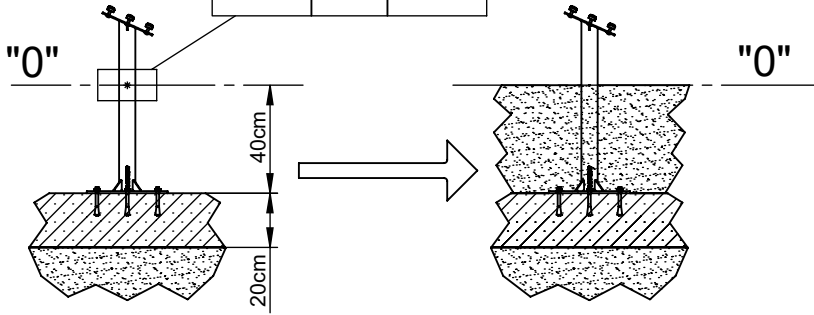

Nr	Element		
61		-	KL105 (OC)

