

9510

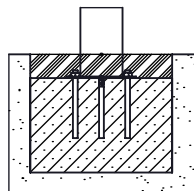

9510N

9510N

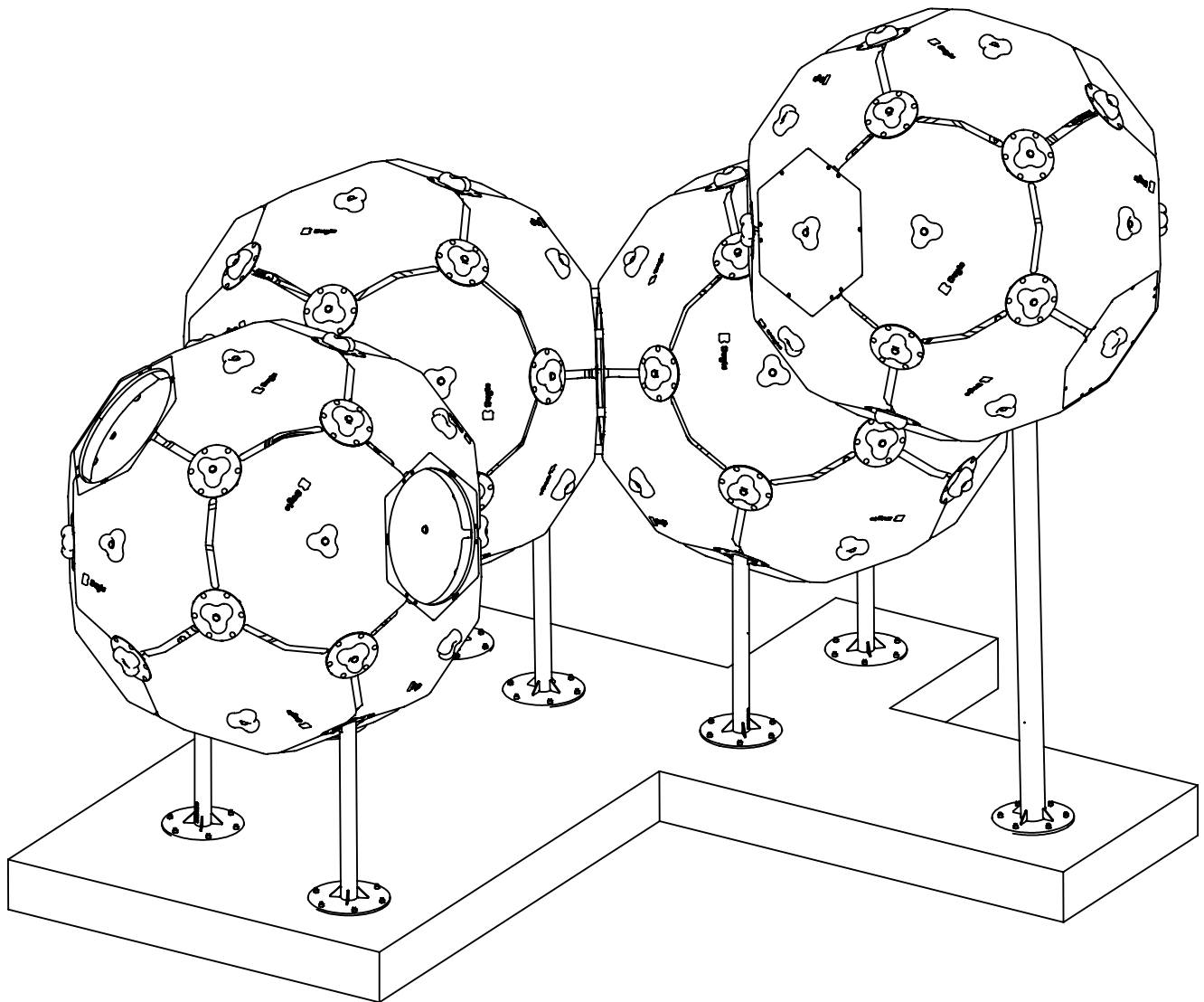
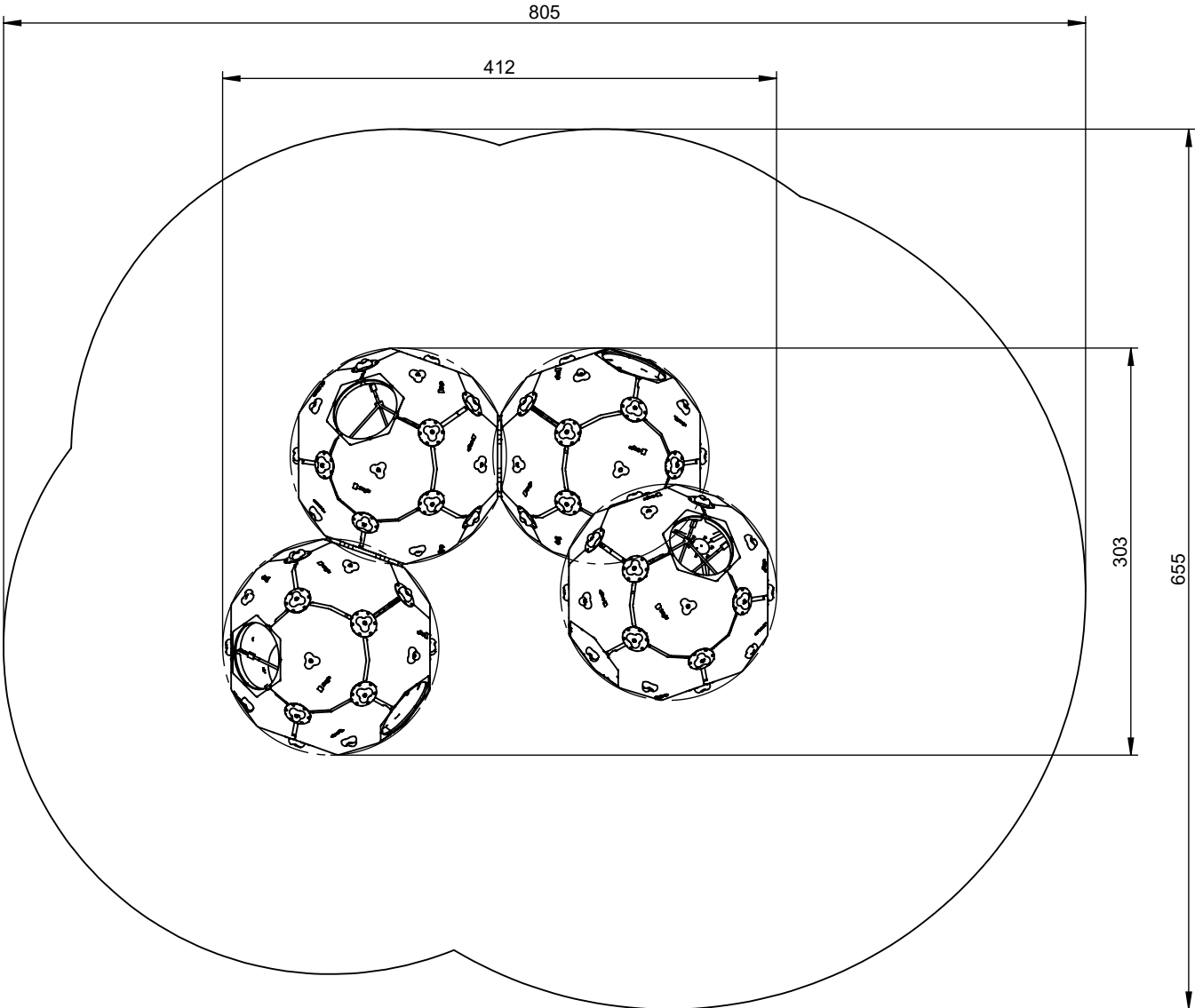
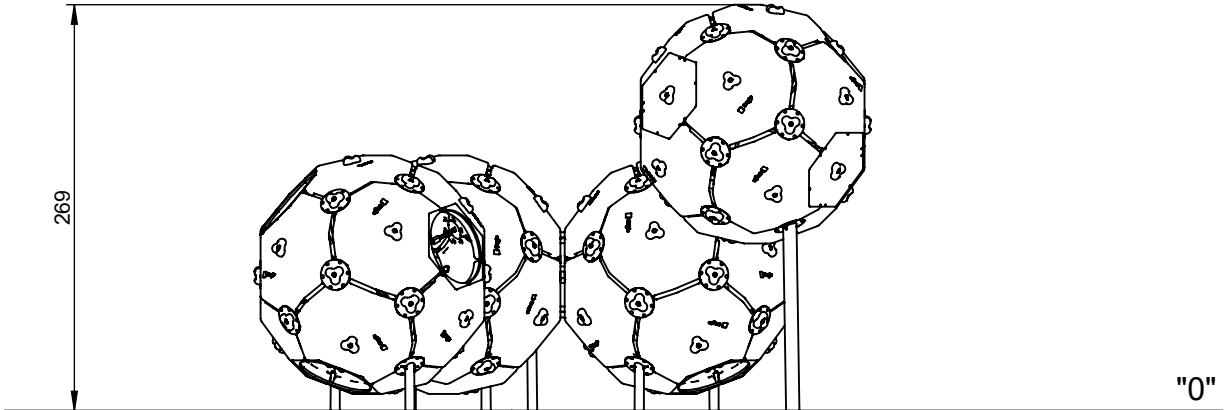

9510N

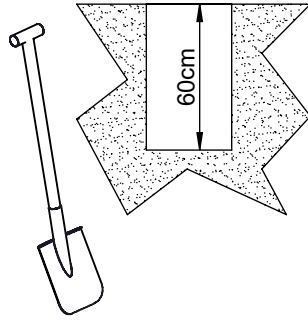

B25 1,34m³

min. 48H

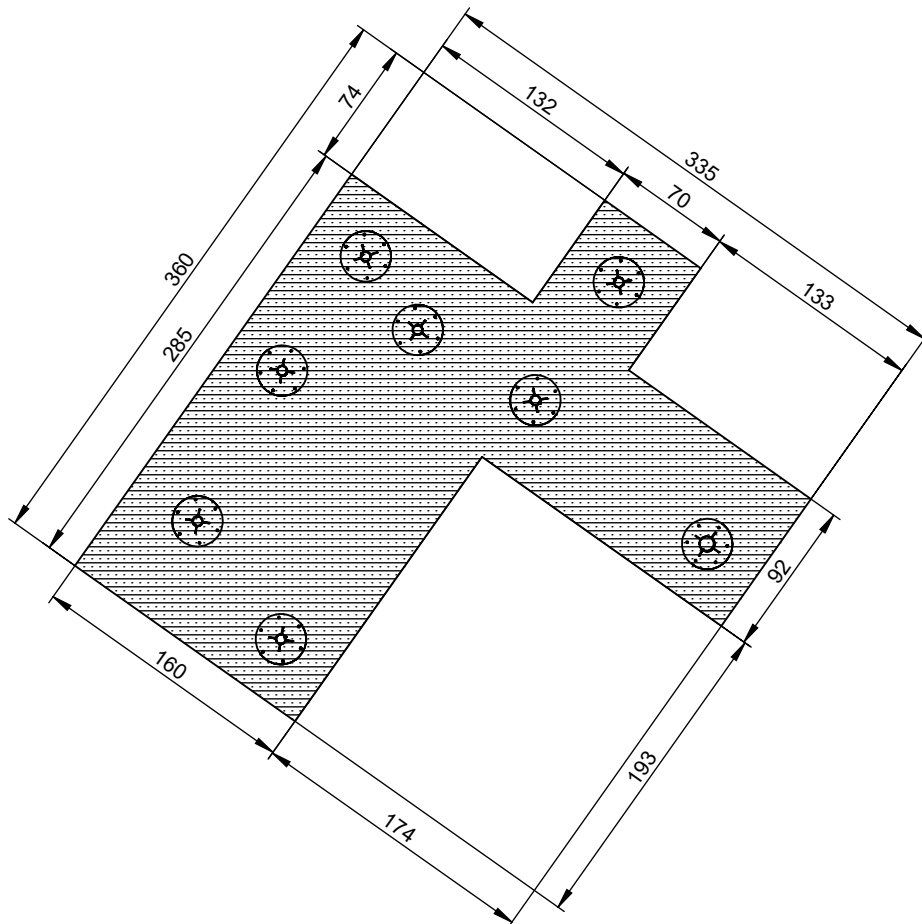
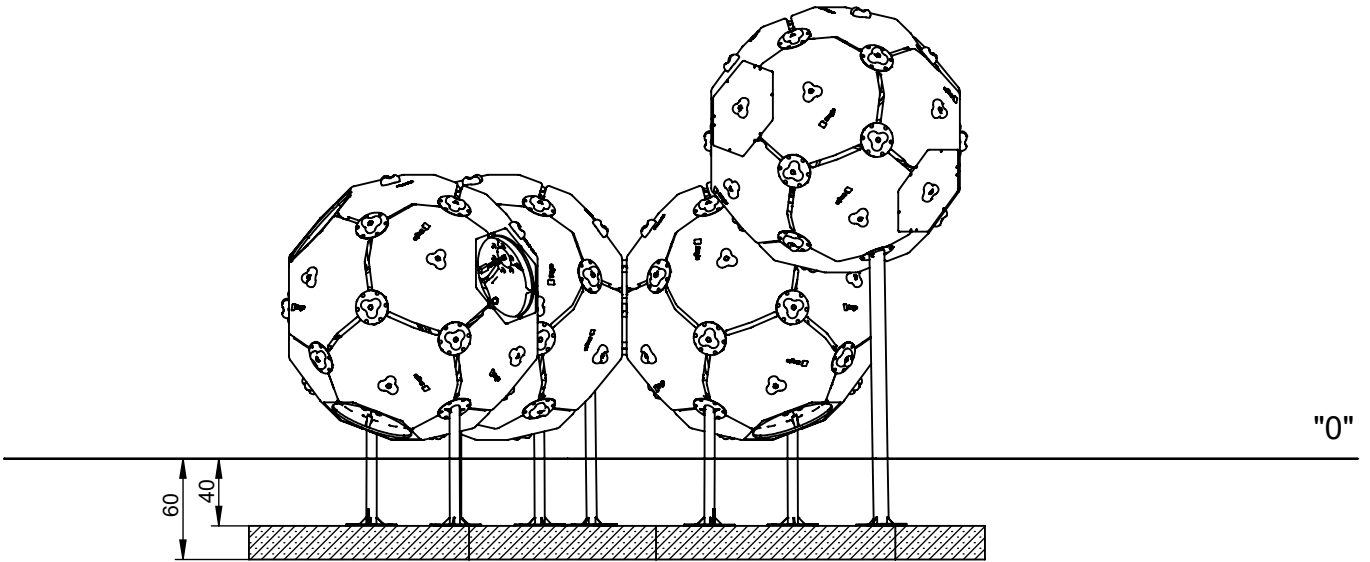
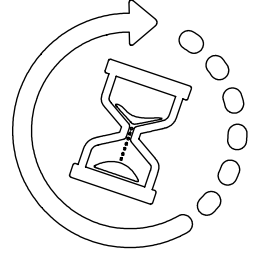
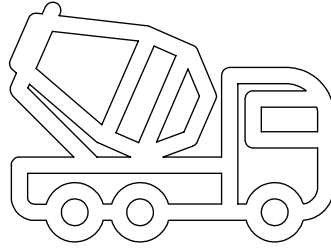

9510N

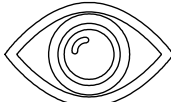

"0"

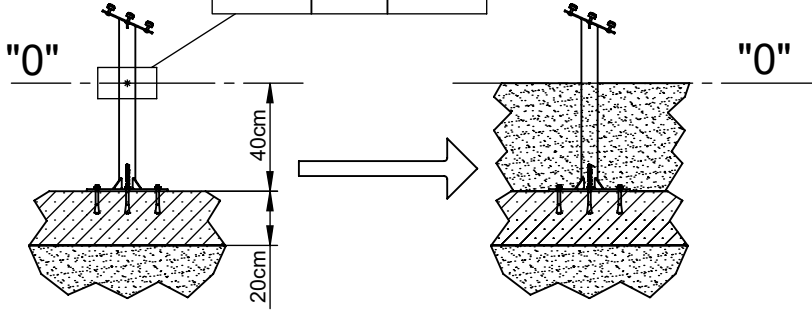

Nr	Element		
61		-	KL105 (OC)

