



VVZ-VZ4-001-15 Tyrkys / Herní sestava do 1,5 m



SPECIFIKACE

Rozměry prvku (d x š x v) 560 x 600 x 360 cm

Dopadová plocha (d x š) 920 x 970 cm

Dopadová plocha (m²) 89,24 m²

Výška volného pádu 150 cm

Věková skupina 3-14 let

V souladu s normou: EN 1176-1: 2017





VVZ-VZ4- Tyrkys / Herní sestava do 1,5 m

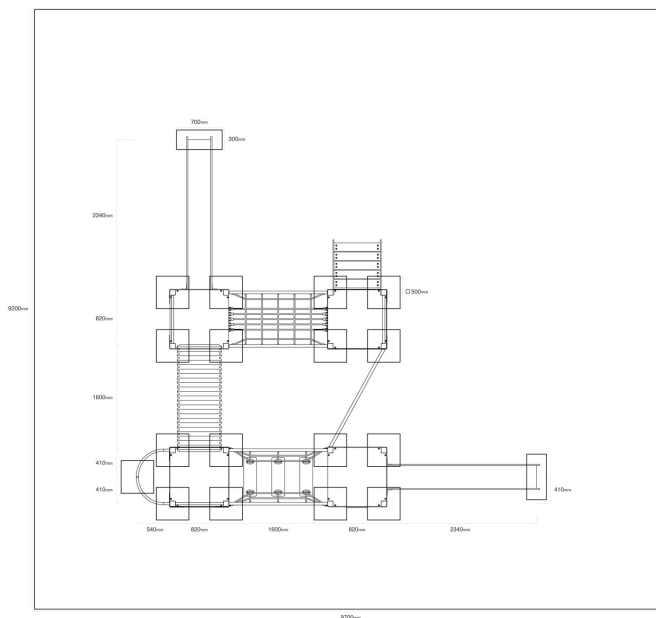

Použité materiály